

### PROMASEAL® WRAP

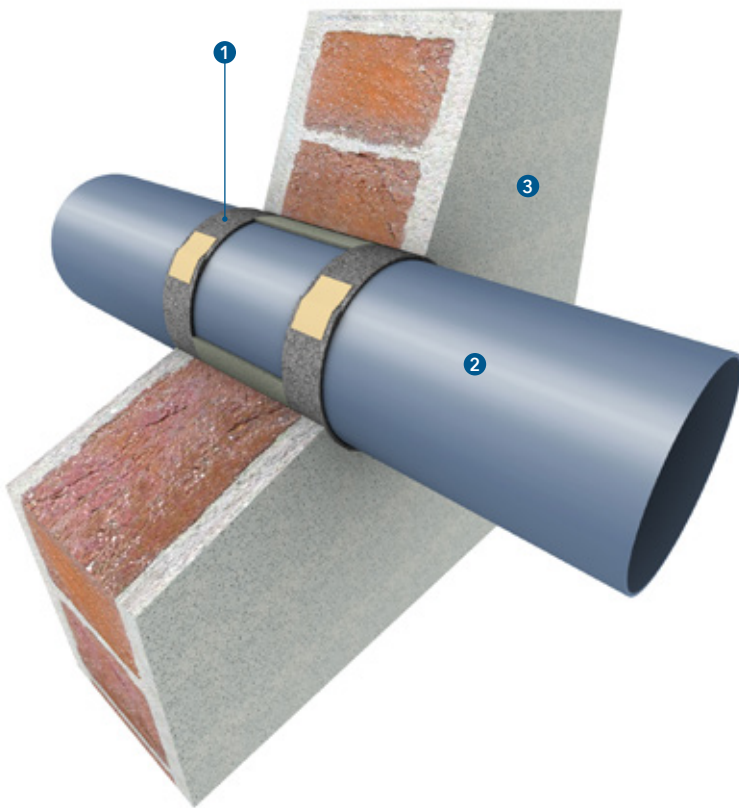

#### LEGEND (see also detail A to C on page 2)

1. PROMASEAL® WRAP
2. Plastic pipes
3. Flexible/rigid wall or rigid floor
4. PROMASEAL® Intumescent Acrylic Sealant

#### APPROVAL

UL-EU-01104-CPR

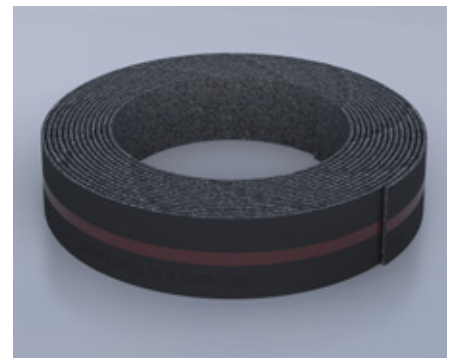

#### PIPE DIAMETER

Up to 250mm

#### PIPE TYPES

HDPE, PE, PP AND PVC

#### WIDTH (NOMINAL)

40mm

#### INSULATION

Phenolic, elastomeric, glass and stone wool

#### THICKNESS (NOMINAL)

2mm per layer. Typically 2mm total thickness for pipe diameter up to 32mm. 10mm total thickness (5 layers) for pipe diameter up to 200mm

#### DENSITY

Approximately 1.2 g/cm<sup>3</sup>

#### VOLUME EXPANSION AT 450°C

Approximately 25 times

#### EXPANSION PRESSURE N/mm<sup>2</sup>

Up to max 1.30

#### FIRE RESISTANCE

Up to EI 120 as per EN 1366-3: 2009 and EN 13501-2

#### GENERAL DESCRIPTION

PROMASEAL® WRAP is designed using graphite intumescent technology and is intended for use to seal service penetration apertures that contain plastic and insulated metal pipes.

The wrap is supplied as a 25m long x 2mm thick intumescent strip, that is intended to be cut to size on site.

Developed to provide a high volume expansion and pressure seal during a fire, PROMASEAL® WRAP provides up to 120 minutes fire protection (EI 120) tested to EN 1366-3, with maximum pipe diameter of 250mm.

The ultra-thin design of PROMASEAL® WRAP ensures that it can be installed in the tightest of locations.

#### FIELDS OF APPLICATION

Penetration seals in flexible walls, in rigid wall and floor constructions and installed in PROMASEAL® Fire Barrier seals.<sup>1</sup>

Penetration seals around non-metallic pipes and insulated metal pipes.

#### INSTALLATION

Ensure that the service penetration has been tested with the PROMASEAL® WRAP (see performance tables) and that the site conditions are within the application specification.

Services to be rigidly supported maximum 400mm from the seal on both sides of the wall and on the upper side of the floor.

All services need to be clean and clear of all dust and loose particles. The aperture temperature needs to be at +5C or above at time of installation.

<sup>1</sup> See PROMASEAL® Fire Barrier data sheet for further information.

Detail A - Combustible pipe penetrating seal in flexible wall

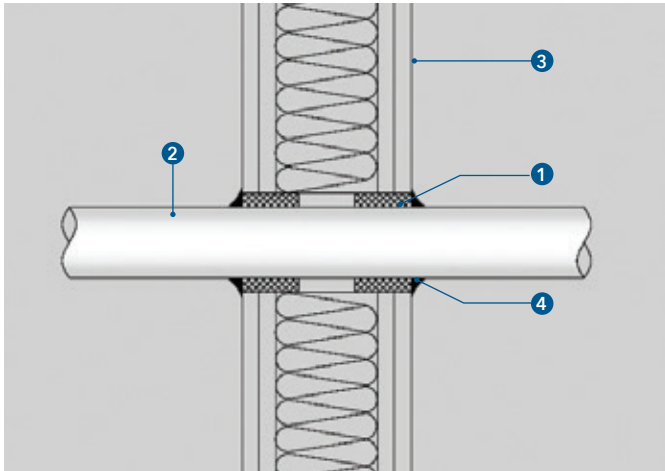

Detail B - Combustible pipe penetrating seal in rigid wall

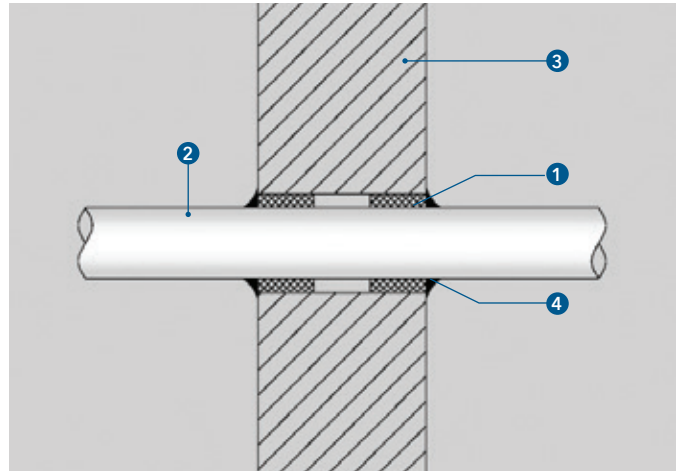

Detail C - Combustible pipe penetrating seal in floor

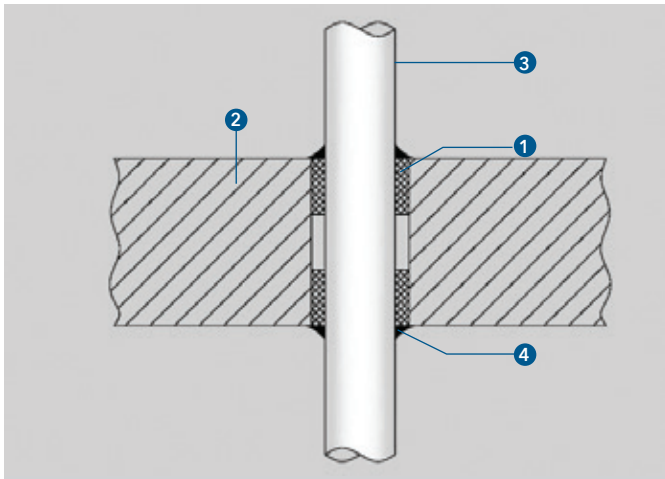

Detail A/B - Combustible pipe in flexible wall and rigid wall

Description	Technical specification
Wall thickness	≥100mm
Sealant position	Both sides
PROMASEAL® WRAP position	Both sides. Wrap recessed 5mm from the face of the wall

Detail C - Combustible pipe in rigid floor

Description	Technical specification
Floor thickness	≥150mm
Sealant position	Both sides
PROMASEAL® WRAP position	Both sides. Wrap recessed 5mm from the face of the floor

An annular space needs to be present around the service to enable the PROMASEAL® WRAP to be applied at sufficient installation depth.

Ensure that the wraps are installed in positions as shown in performance tables and Certification.

Measure correct length of PROMASEAL® WRAP (according to the pipe size and number of layers required) and wrap around the pipe. Ensure that the mesh side of the wrap is facing away from the penetrating service and that the wrap is held in place using tape.

PROMASEAL® WRAP to be installed recessed 5mm from the face of the wall or floor and the annulus filled with PROMASEAL® Intumescent Acrylic Sealant.

Once compacted, smooth off the sealant to produce a professional surface.

### SYSTEM ADVANTAGES / CUSTOMER BENEFIT

- Fire resistance testing in rigid and flexible walls, rigid floors and PROMASEAL® Fire Barrier<sup>1</sup>
- Based on a thermoplastic composite and is therefore non-toxic
- Contains no asbestos, ceramic or mineral fibres.

- Halogen free, resists fungi and vermin
- Can be used with Plastic Pipes – HDPE, PE, PP and PVC
- Can be used in areas of high humidity.

### PACKAGING

PROMASEAL® WRAP is supplied in 25 metre long, 40mm wide roll.

### STORAGE REQUIREMENTS

Store in cool and dry conditions

### SAFETY INSTRUCTIONS

Please refer to the Safety Data Sheet for additional advice.

<sup>1</sup>. See PROMASEAL® Fire Barrier Data Sheet (EN) for further information.

TABLE 1: OVERVIEW OF PVC PIPE INSTALLATION, DIMENSIONS AND CLASSIFICATION FOR FLEXIBLE WALL AND RIGID WALL

Pipe	Minimum wall thickness (mm)	Reference	WRAP Inlay W x T (mm)	Annular gap seal of PROMASEAL® Intumescent Acrylic Sealant (mm)	Fire resistance (mins)	
					E	EI
32mm Ø PVC with 1.8mm wall thickness	100	25m roll PROMASEAL® WRAP	40 x 2 (1 layer) to both faces of the wall	4 (to both faces of wall)	120 U/C	120 U/C
40mm Ø PVC with 1.8mm wall thickness						
50mm Ø PVC with 1.8mm wall thickness						
160mm Ø PVC with 6.2mm wall thickness			40 x 8 (4 layers) to both faces of the wall	10 (to both faces of wall)	90 U/C	90 U/C
160mm Ø PVC with 9.5mm wall thickness					120 U/C	120 U/C
200mm Ø PVC with 7.7mm wall thickness						
200mm Ø PVC with 9.6mm wall thickness			40 x 10 (5 layers) to both faces of the wall	12 (to both faces of wall)		

Plastic pipes PVC according to EN 1452, U/C, wall ≥ 100mm - EI 90

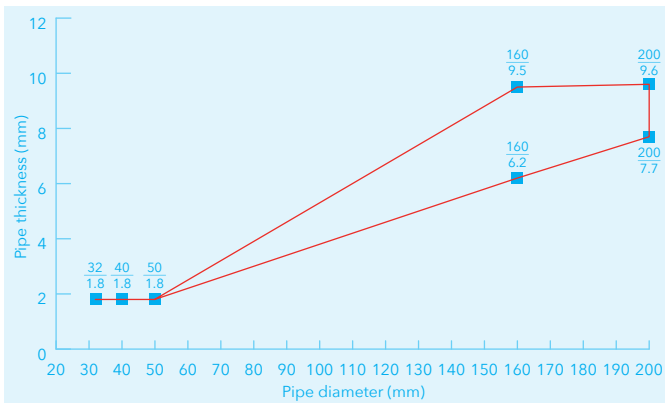

Plastic pipes PVC according to EN 1452, U/C, wall ≥ 100mm - EI 120

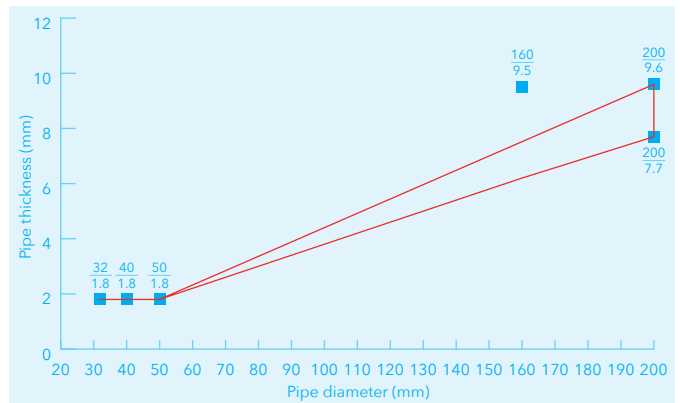
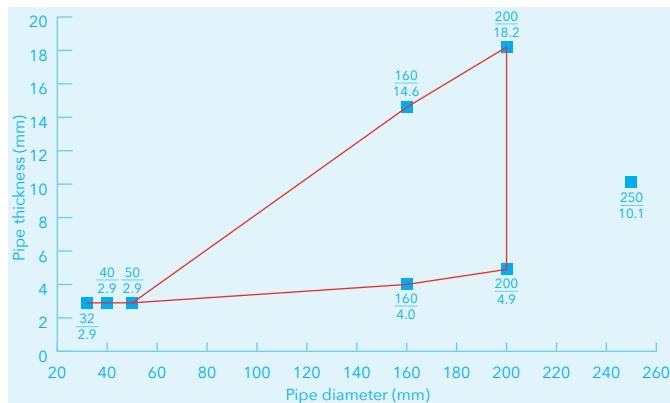

TABLE 2: OVERVIEW OF PP PIPE INSTALLATION, DIMENSIONS AND CLASSIFICATION FOR FLEXIBLE WALL AND RIGID WALL

Pipe	Minimum wall thickness (mm)	Reference	WRAP Inlay W x T (mm)	Annular gap seal of PROMASEAL® Intumescent Acrylic Sealant (mm)	Fire resistance (mins)	
					E	EI
32mm Ø PP with 2.9mm wall thickness	100	25m roll PROMASEAL® WRAP	40 x 2 (1 layer) to both faces of the wall	4 (to both faces of wall)	120 U/C	120 U/C
40mm Ø PP with 2.9mm wall thickness						
50mm Ø PP with 2.9mm wall thickness						
160mm Ø PP with 4.0mm wall thickness			40 x 8 (4 layers) to both faces of the wall	10 (to both faces of wall)	120 U/C	90 U/C
160mm Ø PP with 14.6mm wall thickness					120 U/C	120 U/C
200mm Ø PP with 4.9mm wall thickness			40 x 10 (5 layers) to both faces of the wall	12 (to both faces of wall)	120 U/C	90 U/C
200mm Ø PP with 18.2mm wall thickness					120 U/C	120 U/C
250mm Ø PP with 10.1mm wall thickness			40 x 12 (6 layers) to both faces of the wall	14 (to both faces of wall)	120 U/C	20 U/C

Plastic pipes PP according to EN 1451, wall ≥ 100mm - E 120, EI 20



Plastic pipes PP according to EN 1451, wall ≥ 100mm - E 120, EI 90

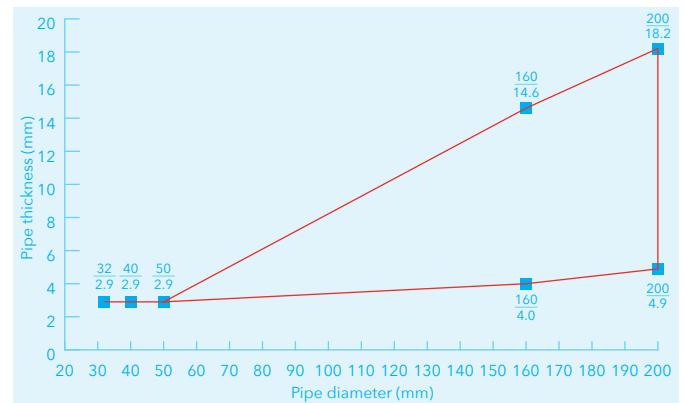

Plastic pipes PP according to EN 1451, U/C, wall ≥ 100mm - EI 120

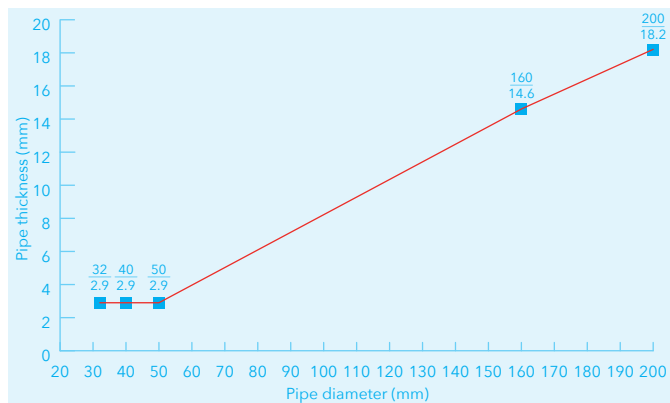
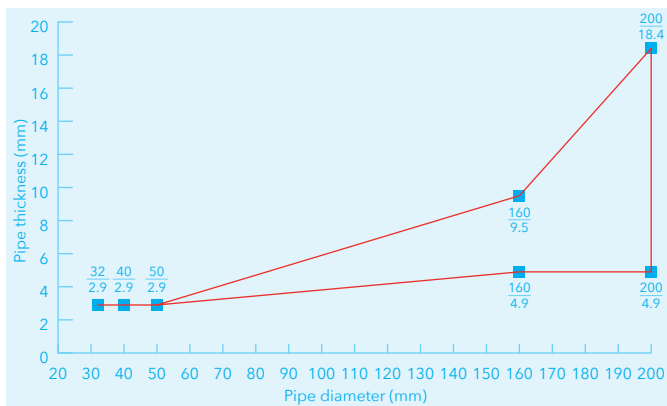

TABLE 3: OVERVIEW OF HDPE PIPE INSTALLATION, DIMENSIONS AND CLASSIFICATION FOR FLEXIBLE WALL AND RIGID WALL

Pipe	Minimum wall thickness (mm)	Reference	WRAP Inlay W x T (mm)	Annular gap seal of PROMASEAL® Intumescent Acrylic Sealant (mm)	Fire resistance (mins)	
					E	EI
32mm Ø HDPE with 2.9mm wall thickness	100	25m roll PROMASEAL® WRAP	40 x 2 (1 layer) to both faces of the wall	4 (to both faces of wall)	120 U/C	120 U/C
40mm Ø HDPE with 2.9mm wall thickness						
50mm Ø HDPE with 2.9mm wall thickness						
160mm Ø HDPE with 4.9mm wall thickness			40 x 8 (4 layers) to both faces of the wall	10 (to both faces of wall)	15 U/C	15 U/C
160mm Ø HDPE with 9.5mm wall thickness					90 U/C	90 U/C
200mm Ø HDPE with 4.9mm wall thickness			40 x 10 (5 layers) to both faces of the wall	12 (to both faces of wall)	15 U/C	15 U/C
200mm Ø HDPE with 18.4mm wall thickness					120 U/C	120 U/C

Plastic pipes PE according to EN ISO 15494, wall ≥ 100mm - EI 15



Plastic pipes PE according to EN ISO 15494, wall ≥ 100mm - EI 90

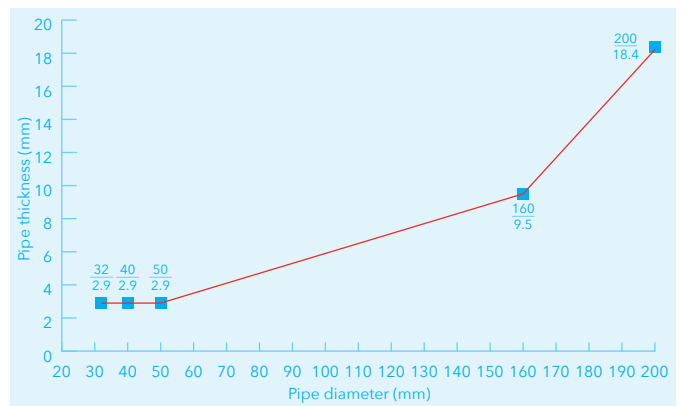

Plastic Pipes PE according to EN ISO 15494, U/C, wall ≥ 100mm - EI 120

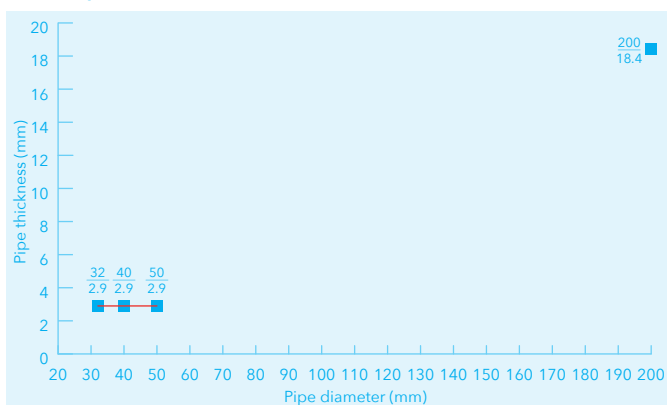
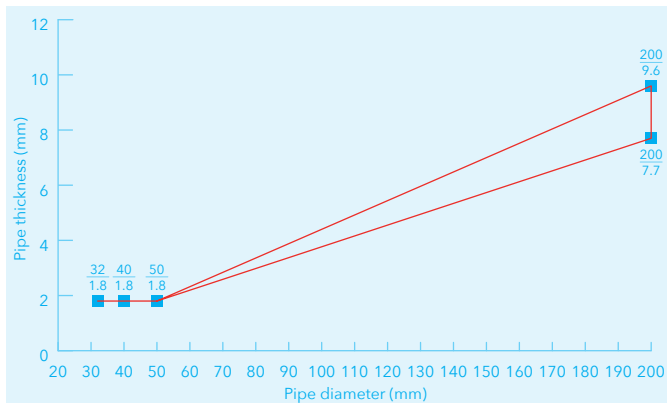

TABLE 4: OVERVIEW OF PVC PIPE INSTALLATION, DIMENSIONS AND CLASSIFICATION FOR RIGID FLOOR

Pipe	Minimum floor thickness (mm)	Reference	WRAP Inlay W x T (mm)	Annular gap seal of PROMASEAL® Acrylic Sealant (mm)	Fire resistance (mins)	
					E	EI
32mm Ø PVC with 1.8mm wall thickness	150	25m roll PROMASEAL® WRAP	40 x 4 (2 layers) to both faces of the floor	4 (to both faces of floor)	120 U/C	120 U/C
40mm Ø PVC with 1.8mm wall thickness						
50mm Ø PVC with 1.8mm wall thickness						
200mm Ø PVC with 7.7mm wall thickness			40 x 10 (5 layers) to both faces of the floor	12 (to both faces of floor)	120 U/C	90 U/C
200mm Ø PVC with 7.7mm - 9.6mm wall thickness					60 U/C	60 U/C

Plastic Pipes PVC according to EN 1452, U/C, Floor ≥ 150mm - EI 60



Plastic pipes PVC according to EN 1452, U/C, Floor ≥ 150mm - E 120, EI 90

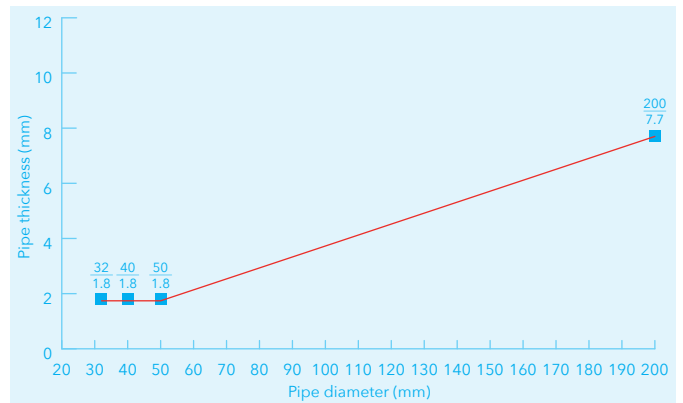

Plastic pipes PVC according to EN 1452, U/C, Floor ≥ 150mm - EI 120

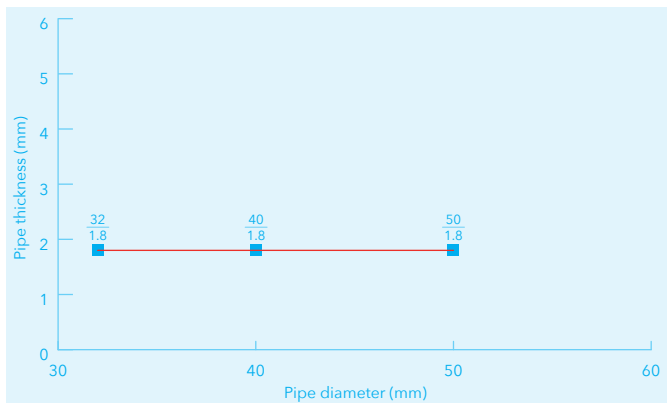
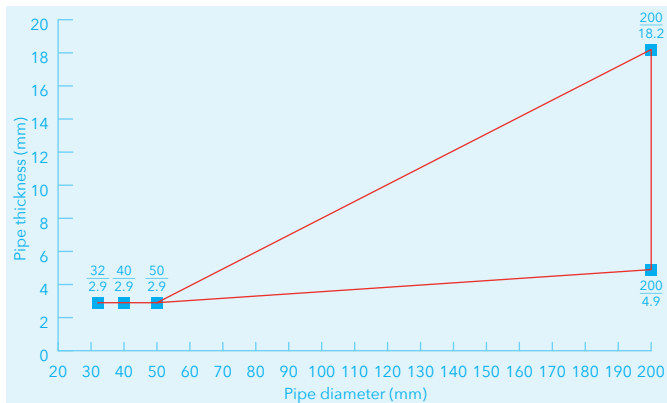

TABLE 5: OVERVIEW OF PP PIPE INSTALLATION, DIMENSIONS AND CLASSIFICATION FOR RIGID FLOOR

Pipe	Minimum floor thickness (mm)	Reference	WRAP Inlay W x T (mm)	Annular gap seal of PROMASEAL® Acrylic Sealant (mm)	Fire resistance (mins)	
					E	EI
32mm Ø PP with 2.9mm wall thickness	150	25m roll PROMASEAL® WRAP	40 x 4 (2 layers) to both faces of the floor	4 (to both faces of floor)	120 U/C	120 U/C
40mm Ø PP with 2.9mm wall thickness						
50mm Ø PP with 2.9mm wall thickness						
200mm Ø PP with 4.9mm wall thickness	150	25m roll PROMASEAL® WRAP	40 x 10 (5 layers) to both faces of the floor	12 (to both faces of floor)	20 U/C	15 U/C
200mm Ø PP with 18.2mm wall thickness					120 U/C	90 U/C

Plastic pipes PP according to EN 1451, U/C, Floor ≥ 150mm - E 20, EI 15



Plastic pipes PP according to EN 1451, U/C, Floor ≥ 150mm - E 120, EI 90

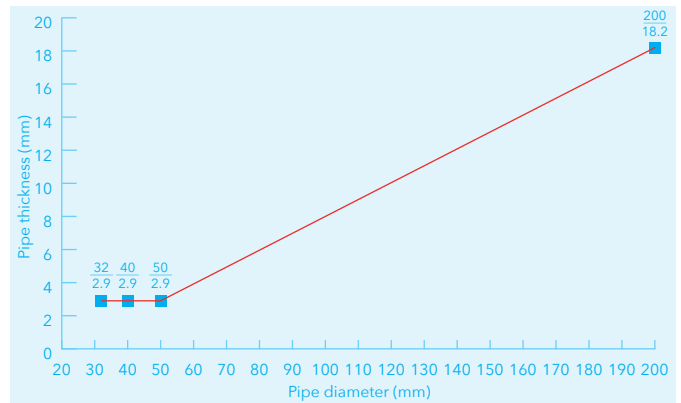

Plastic pipes PP according to EN 1451, U/C, Floor ≥ 150mm - EI 120

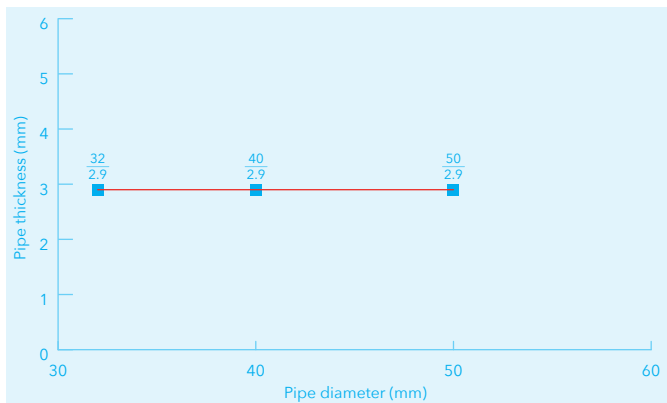
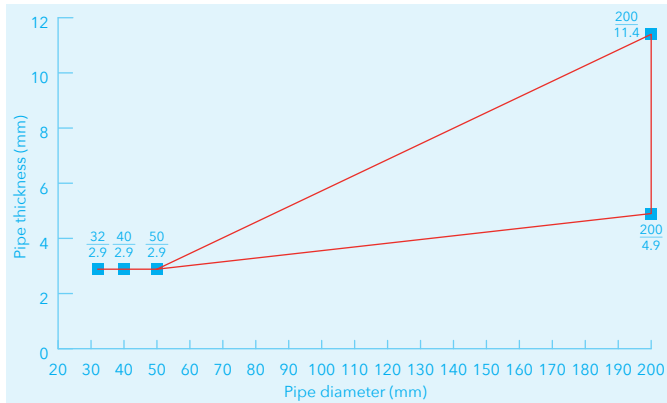

TABLE 6: OVERVIEW OF HDPE PIPE INSTALLATION, DIMENSIONS AND CLASSIFICATION FOR RIGID FLOOR

Pipe	Minimum floor thickness (mm)	Reference	WRAP Inlay W x T (mm)	Annular gap seal of PROMASEAL® Acrylic Sealant (mm)	Fire resistance (mins)	
					E	EI
32mm Ø HDPE with 2.9mm wall thickness	150	25m roll PROMASEAL® WRAP	40 x 4 (2 layers) to both faces of the floor	4 (to both faces of floor)	120 U/C	120 U/C
40mm Ø HDPE with 2.9mm wall thickness						
50mm Ø HDPE with 2.9mm wall thickness						
200mm Ø HDPE with 4.9mm wall thickness			40 x 10 (5 layers) to both faces of the floor	12 (to both faces of floor)		
200mm Ø HDPE with 11.4mm wall thickness						

Plastic pipes HDPE according to EN 1519, U/C, floor ≥ 150mm - EI 120



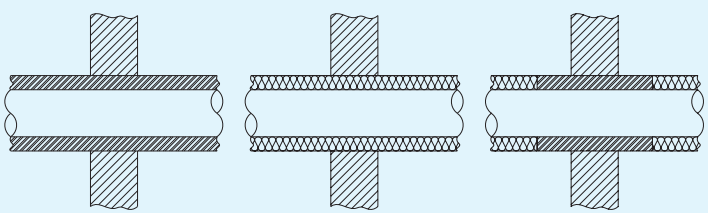
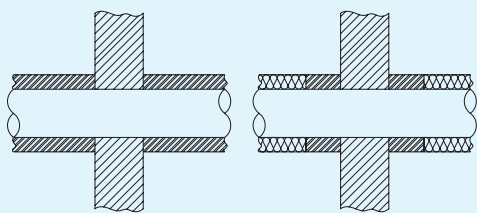
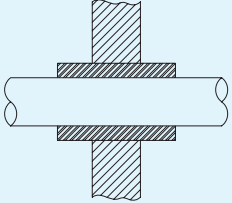
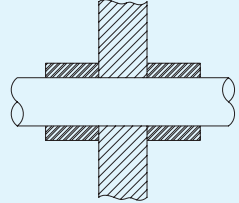

### PIPE INSULATION ACCORDING TO EN 1366-3: 2009

	Local Sustained	Local Interrupted
Local: (sustained along the tube length)	 <p>Example CS (Continued Sustained)</p>	 <p>Example CI (Continued Interrupted)</p>
Local: (sectional insulation)	 <p>Example LS (Local Sustained)</p>	 <p>Example LI (Local Interrupted)</p>

The table above shows the possible arrangement of pipe insulation according to EN 1366-3.

### CONFIGURATION OF PIPE END ACCORDING TO EN 1366-3: 2009

Test Condition	Pipe and configuration		Type of pipes
	Oriented inside (in furnace)	Oriented outside (outside the furnace)	
U/U	Uncapped	Uncapped	Plastic: rainwater, ventilated sewage (drainage channel)
U/C	Uncapped	Capped	Plastic: unventilated sewage; gas; drinking water, water for heating; (supply channel); metal: non-fire resistant suspension/coupling systems
C/U	Capped	Uncapped	Metal: fire-resistant suspension/coupling systems
C/C	Capped	Capped	–

It is important to ensure that sealing systems have been tested with appropriate pipe end conditions.

The conditions the pipe and sealing system must endure in a fire situation depend on whether one or both ends of the pipe are sealed in practice, as pressures and the flow of hot gases will vary depending on whether the pipe is ventilated or not.

There are rules that determine which tested end configurations are valid for additional pipe end situations.

#### For metal pipes

		Tested			
		U/U	C/U	U/C	C/C
Covered	U/U	Y	N	N	N
	C/U	Y	Y	Y	N
	U/C	Y	N	Y	N
	C/C	Y	Y	Y	Y

#### For plastic pipes

		Tested			
		U/U	C/U	U/C	C/C
Covered	U/U	Y	N	N	N
	C/U	Y	Y	N	N
	U/C	Y	Y	Y	N
	C/C	Y	Y	Y	Y

Y = Acceptable N = Not acceptable

### Terms

UL Listing	UL certifies, validates, tests, inspects and audits. The UL Mark is the most common Certification Mark in the United States and Europe. If a product carries one of these marks, it means UL found that the representative product samples met UL's requirements.
Flexible Walls	A wall made from steel stud, 2 layers of Type F gypsum boards and mineral wool cavity with a thickness and make up appropriate to the required fire resistance classification.
Rigid Walls	A wall made of aerated concrete slabs, lightweight concrete or high density concrete and a thickness appropriate to the required fire resistance classification. Masonry/concrete walls to have minimum density of 700kg/m <sup>3</sup> for concrete or brick and 600kg/m <sup>3</sup> for aerated concrete blocks.
Rigid Floors	A floor made of aerated concrete slabs, lightweight concrete or high density concrete and a thickness appropriate to the required fire resistance classification. Masonry/concrete floors to have minimum density of 700kg/m <sup>3</sup> for concrete or brick and 600kg/m <sup>3</sup> for aerated concrete blocks.
EN 1366-3 EN 1366-4	Fire Resistance tests for service installations. Penetration seals. Fire Resistance tests for service installations. Linear joint seals.
EN 13501-1 EN 13501-2	Reaction to Fire Classification. Resistance to Fire Classification.
BS 476	Pt 20: Fire tests on building materials and structures. Method for determination of the fire resistance of elements of construction (general).Pt 22: Fire tests on building materials and structures. Methods for determination of the contribution of components to the fire resistance of a structure.

Supplement markings	Denomination / Characteristics / Requirements
E	Integrity (ignition of cotton pad, cracks and opening occurrence of sustained flaming on unexposed side)
I (I1, I2)	Thermal insulation (average temperature rise, maximum temperature rise)
U	Pipe end configuration »uncapped«
C	Pipe end configuration »capped«

**AUTHORITY: UL-EU-01104-CPR**



**Etex Building Performance Limited**

Marsh Lane, Bristol BS20 0NE | 0800 145 6033

technical.promat@etexbp.co.uk | www.promat.co.uk