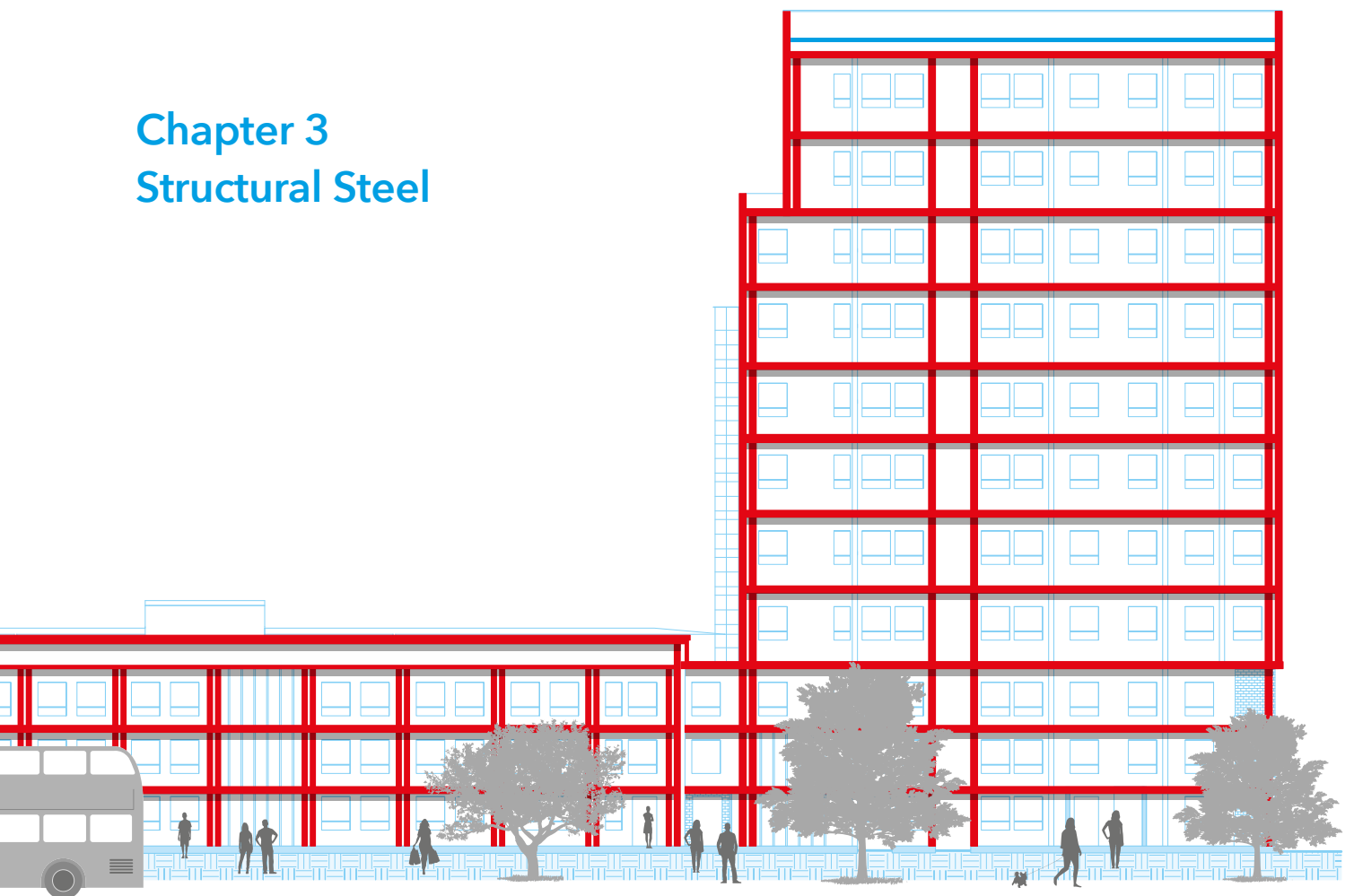


Promat

The Passive Fire Protection Handbook

The UK's comprehensive guide to passive fire protection

Chapter 3 Structural Steel



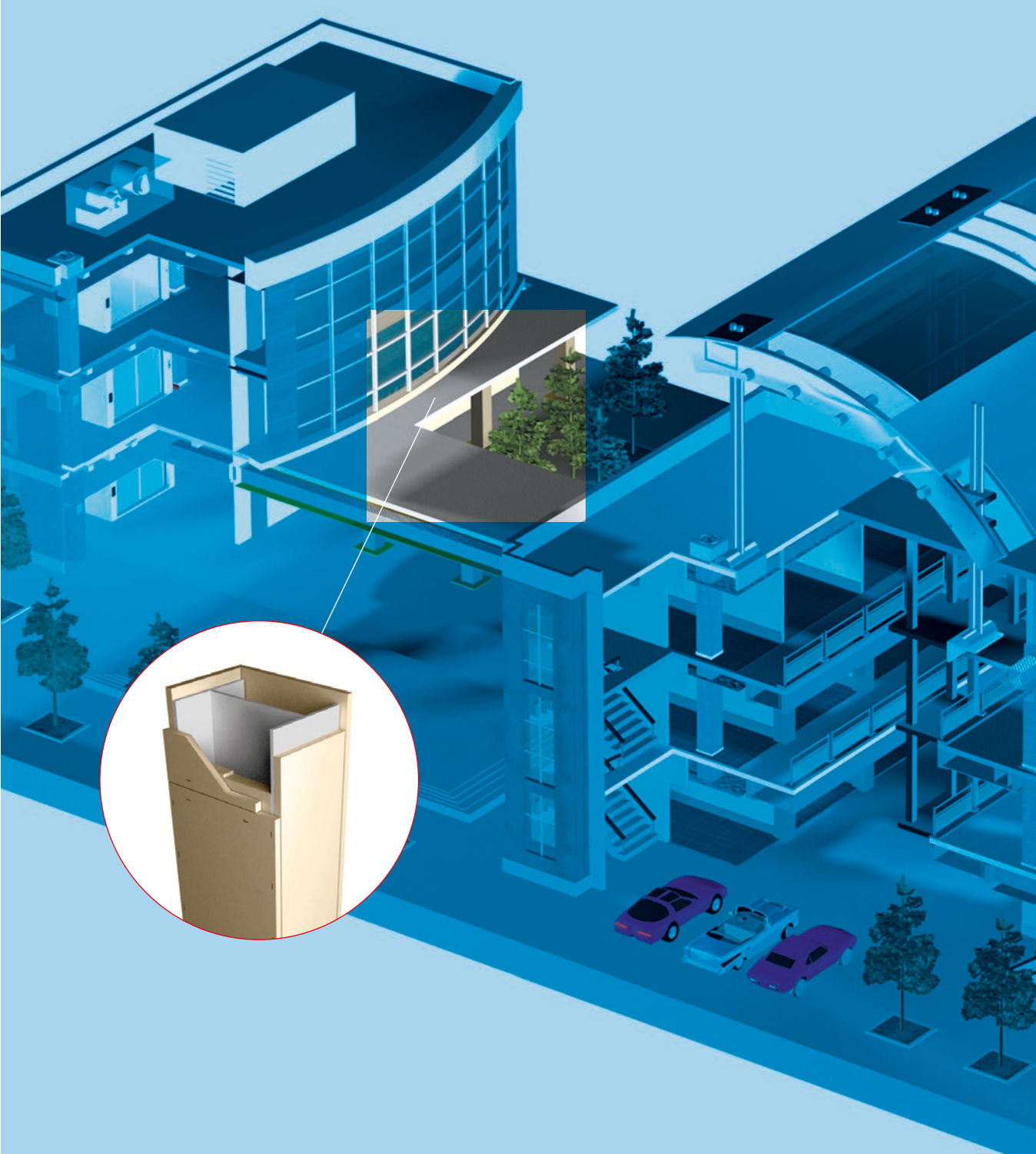
JUNE 2022



Contents

Chapter 3: Structural Steel	37
Introduction	38
Calculation of A/V Values.....	40
A/V Tables for Steelwork Encasements.....	43
Promat VERMICULUX® Encasements.....	63
Promat PROMATECT®-250	72
Promat SUPALUX® 3-Sided Columns and Beams	82
Promat SUPALUX®	83
Promat TD Board®	84
Timber Column Cladding.....	98
Design Considerations.....	99
Sprayed Systems, CAFCO® 300	100
Sprayed Systems, Cafco MANDOLITE® CP2	101
Sprayed Systems, Cafco FENDOLITE® MII.....	103

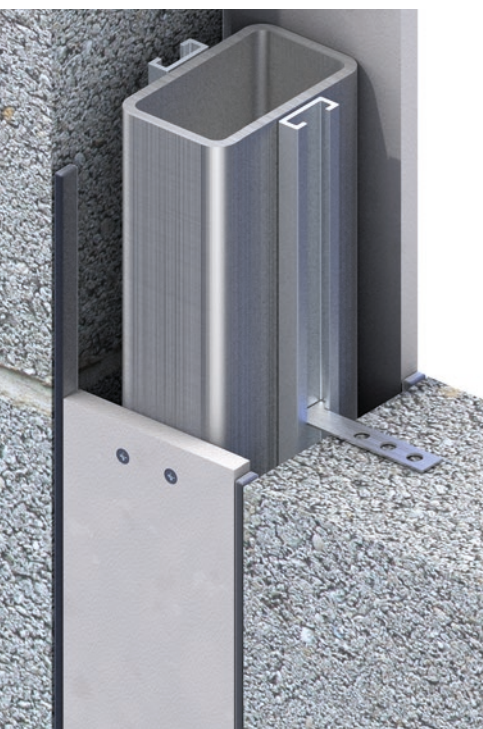
Chapter 3: Structural Steel
Structural Steel



Introduction

The amount of fire protection required to achieve this depends on the following:

- Duration of fire resistance specified
- Type of protection used
- Perimeter of the steel section exposed to fire
- Shape and size of the steel section



STRUCTURAL STEEL

The Building Regulations require certain elements of structure to have fire resistance for a specified minimum period of time. The amount of fire protection required to achieve this depends on the following:

- Duration of fire resistance specified
- Type of protection used
- Perimeter of the steel section exposed to fire
- Shape and size of the steel section

To determine how these factors affect fire resistance, all Promat products and systems have been tested at accredited laboratories to a variety of standards, e.g. BS 476: Part 21: 1987, DIN 4102 and ASTM E119.

Tests in accordance with BS 476: Part 21: 1987 have been performed on loaded beams and columns clad with Promat fire protection materials. Steel temperatures are monitored with thermocouples to assess the performance of the fire protection, since steel fully stressed in accordance with BS 449: Part 2: 1969 or BS 5950: Part 1: 2000 begins to lose its design margin of safety at temperatures around 550°C.

A range of unloaded sections has also been tested to obtain data for calculating exactly how much protection is needed for the most common steel sections and for providing fire resistance for different time periods.

These and other tests have also demonstrated the ability of the fire protection to remain in place, commonly termed as the 'stickability' of the material, for the maximum duration for which protection may be required. The availability of thin boards and the low weight of Promat boards plus the possibility of prefabrication ensure maximum cost-efficiency.

Cellular Beams

To satisfy building design requirements, steel beams are now available with a variety of apertures created in the basic section size, during a secondary manufacturing process, to form deeper cellular beams than the parent beam. Alternatively, cellular beams can be created from three flat steel plates welded together.

Whilst rectangular and/or elliptical 'elongated' aperture shapes are available, most apertures are circular in shape. A large range of circular aperture sizes and spacing/pitch is available. The dimensions of the residual 'web post' can significantly affect the performance of the cellular beam in fire. The method of calculating section factor AND fire protection thickness for cellular beams is considered to be different than for other solid steel sections. Further guidance on these systems is shown in the calculation of A/V values part of this document.

Structural Hollow Section

The same thickness of Promat materials can be used on hollow sections as on 'I' sections of the same A/V value.

Bracing

Bracing is included in a structure to give resistance to wind forces and provide overall stiffness. Masonry walls and steel cladding contribute to a structure's stiffness but these are rarely taken into account in design. Also, the probability of a major fire occurrence being concurrent with maximum wind load is remote. Therefore, it seems unreasonable to apply the 550°C steel temperature criteria to bracing.

Whilst each case must be judged on its merits, generally protection to bracing is not necessary but where it is required the A/V value of the bracing section or 200m⁻¹ should be used, whichever is the lower value.

Lattice Members

As the determination of the protection necessary to protect lattice members requires broad consideration of the lattice design, please consult Promat Technical Services Department for advice concerning such steel sections.

Introduction

Partially Exposed Members

Where columns or beams are partly built into or are in close contact with walls or floors, then account can be taken of the protection afforded to the steelwork by the wall or floor. In the case of masonry work, this will give protection to the adjacent surface of the steelwork for the purpose of determining the heated perimeter.

External Lightweight Walls

In the case of portal legs supporting a lightweight external wall, the insulation performance required by the wall will contribute to the protection of any column flange falling within the thickness of the wall. In this case please consult Promat Technical Services Department to confirm the board thickness and how many sides of the column should be protected.

Internal Lightweight Walls/Partitions

Where a column or beam is built into a fire resistant lightweight wall or partition, the protection of the steelwork can generally be designed on the assumption that only one side of the wall or partition will be exposed to fire at any one time. The wall or partition should be adequately secured to the column in such a way as to ensure the wall or partition will not apply stress on the column encasement. Consideration should also be given to the need for fire compartmentation in this situation.

Floors

Where beams are wholly within the cavity of a timber floor protected by a Promat SUPALUX® ceiling then test evidence shows that the cavity air temperature of the floor is such that the beam will be adequately protected to the same fire resistance by the ceiling that protects the floor. Where the beam is wholly or partly below the line of the Promat SUPALUX® ceiling, the A/V should be based upon the portion of the steel beam that is below ceiling level.

Deflection Heads

The latest version of Approved Document B states that “The predicted deflection of a floor, in the event of a fire, should be accommodated in the design of compartment walls”. Therefore, consideration should be given to this issue during the design stage.

Beams Supporting Composite Floors with Profiled Metal Decking

A series of fire resistance tests, jointly sponsored by ASFP members (including Promat) and other organisations, demonstrated that it is not always necessary to fill the void formed between the top flange of a beam and the underside of a profiled steel deck. Recommendations based on the research have been published by the Steel Construction Institute (SCI), and are, for decks running normal to the beams, as shown below. Further information can be found in table 3bl on [page 97](#).

Wind Posts

Wind posts are a common way of providing lateral support to tall masonry walls in modern steel-framed buildings. In situations where the walls are also required to provide fire resistance between two compartments (or at a boundary position), the fire protection applied to the wind posts must also maintain the fire separation across the wall construction at that point.

LIGHT GAUGE COLD ROLLED SECTIONS

This type of section would normally necessitate separate appraisal because of the high A/V values and the manner in which the sections are formed which can influence their failure criteria. Research is continuing to formulate recommendations for the application of data given in this publication. Some information on the protection of cold formed members is given in the SCI publication 129 - “Building design using cold formed members”. There are a variety of sections formed from cold rolled sections and normally each would require separate appraisal.



Calculation of A/V Values

A/V SECTION FACTOR

The degree of fire protection depends on the A/V section factor for the steel section. The A/V factor is a function of the area of the steel exposed to the fire and the volume of the steel section. The higher the A/V, the faster the steel section heats up, and so the greater the thickness of fire protection material required. The section factor and limiting temperature are then used to determine the thickness of protection required.

LIMITING TEMPERATURES

Historically, the thickness of fire protection was specified such that the maximum temperature of 550°C for columns and 620°C for beams (supporting concrete floors) were not exceeded for a given period of time.

A more detailed understanding of performance of structural steel has shown that this may have been a simplistic representation of the behaviour of structural steel at these temperatures.

To aid structural engineers, we therefore now include tables to demonstrate performance of structural steel at a series of temperatures.

In cases where the actual limiting temperature required for the steel section does not match limiting temperature figures quoted in product tables, the temperature should be rounded down.

Table 3bs. Heated perimeter (A) for universal beams, universal columns, RSJ's and other sections

Cased on:	4 sides	3 sides	3 sides	2 sides	1 side
A =	2 B + 2 D	B + 2 D	B + 2 d	B + D	B

Note: For partially exposed members, the V value is still the total cross section being protected.

Example 1: Steel beam, serial size 406mm x 178mm x 54kg/m to be encased on three sides.

Serial size	=	406mm x 178mm
Actual size	=	402.6mm x 177.6mm
A	=	B + 2 D
	=	177.6 + 402.6 + 402.6
	=	982.8mm (0.9828m)
V	=	68.4cm ² (0.00684m ²)
A/V	=	0.9828 ÷ 0.00684
	=	143.7
	=	144m ⁻¹

The value of V, the cross-sectional area, can be obtained either from steelwork tables or by accurate measurement. However, if the mass per metre is known then the A/V value can be calculated as below:

$$\frac{A}{V} = \frac{7850 \times A}{W}$$

Where W = Mass of steel section per metre (kg/m)

Where 7850 = Nominal density of steel (kg/m³)

Example 2: Steel beam, serial size 406mm x 178mm x 54kg/m to be encased on three sides.

Serial size	=	406mm x 178mm
Actual size	=	402.6mm x 177.6mm
A	=	B + 2 D
	=	177.6 + 402.6 + 402.6
	=	982.8mm (0.9828m)
A/V	=	$\frac{7850 \times A}{W}$
	=	$\frac{7850 \times 0.9828}{54}$
	=	142.9
	=	143m ⁻¹

Once the specific A/V value is ascertained by either of the above methods, the required thickness of the boards needed for the period of fire protection can be obtained using the A/V tables.

BEAMS WITH WEB OPENINGS (CELLULAR BEAMS)

The following text relates to guidelines laid down in the ASFP Yellow Book "Fire Protection for Structural Steel in Buildings" 5th Edition 2014.

This Section presents guidance with respect to the evaluation of the fire resistance performance of structural steel beams with openings in the web and protected against fire by passive fire protection systems (typically spray coatings, slabs, renderings and boards).

Long span beams with web openings are commonly known as "cellular beams" and have numerous openings in the web to accommodate service items such as pipes and ducts. The provision of the openings for the service items allows longer spans and a reduced storey height for more economic building construction. The openings can be circular, square, or rectangular, although circular openings are most commonly used.

It is considered that castellated beams are one form of cellular beams. Fire test experience has shown that the temperature of castellated members may increase at a slightly faster rate than the conventional parent sections and that an increase in the fire protection thickness is prudent.

Although minimal steel is effectively removed from the parent steel section volume, the steel depth is increased.

Cellular beams can be manufactured by cutting shaped apertures of an appropriate pattern in the web of the parent sections and re-welding the parts together to form a deeper web beam with openings in the web. They can also be manufactured by welding three plates together, with holes pre-cut in the plate forming the web.

The beams may be asymmetrical i.e. have different sized upper and lower portions or flanges.

The introduction of openings in the web of the steel beam means the structural capability of the beam differs from that of a solid beam in that the failure mode in fire is related to the closeness of holes and the web slenderness in addition to section factor. Structural failure can be through Vierendeel bending above the opening or buckling of the web post. These failure modes generally occur at lower temperatures than a plain beam of the same size.

Therefore, it is necessary that such beams are structurally evaluated taking into account all possible modes of structural failure under both ambient and fire conditions.

Due to the different behaviour of cellular beams it is necessary for additional thermal data to be measured around the web openings and on the web posts. The additional thermal data to be used in conjunction with a structural model to determine limiting temperatures of beams with web openings.

There are currently a number of structural models that can be used to determine the structural capability of beams with openings in the web. The Steel Construction Institute (SCI) published a number of structural models over a period of time based on progressive improvements which uses data derived from tests on products supplied by ASFP members to an agreed test programme.

A new European standard for the evaluation of products protecting cellular beams, EN 13381-9 has now been published. This refers to the use of structural engineering models, which take into account the variety of failure modes, e.g. Vierendeel bending, to generate appropriate limiting temperatures.

BOX PROTECTION

In calculating the section factor values the full volume, V , is used whether the section is exposed on three or four sides as the whole of the steel section will be receiving heat. The value of A is the exposed surface area and that depends on the configuration of the fire protection. In the case of a 'box' protection, the surface area is taken as the sum of the inside dimensions of the smallest possible rectangular or square encasement (except in the case of circular hollow sections, where the air space created by boxing a circular section improves the insulation, allowing for reduced material thicknesses by calculating the circumference of the steel tube) whilst for a 'profile' protection, it is taken as the external surface area of the steel section itself. Where a section supports a floor or is against a wall which themselves provide fire protection, the surface in contact is ignored in calculating A . For 'solid' protection the Section Factor value should be taken as that for box protection.

Encasements following the profile of the steel section will generally have a higher A/V section factor than a box encasement. One exception is circular hollow sections as detailed in the following pages.

Please contact Promat Technical Services Department for further advice if required.

The serial size and mass per metre of most steel sections are available in tables from steel manufacturers, which also give A/V values calculated for 3 or 4-sided box protection. Further tables are given in the ASFP Publication "Fire Protection for Structural Steel in Buildings" (the Yellow Book). Promat Technical Services Department can calculate A/V section factors and required board thicknesses on request.

Chapter 3: Structural Steel

Calculation of A/V Values

Section factor for standard steel sections are shown. Please consult a qualified structural engineer for detailed advice if steel sizes fall outside those shown.

To provide a consistent structural approach for these beams, the ASFP sponsored the SCI to produce a model capable of considering a wide range of beam designs and opening shapes and spacing. The SCI have published this method under their reference RT 1356. The latest version can be found on www.steelbiz.org.

The method of RT 1356 determines the limiting temperature at which structural failure will occur for all variations of beam sizes, opening shapes and spacing between openings.

In order to use the principles of RT 1356 it is necessary for the assessment of solid beams to take the form of an elemental multiple temperature analysis (EMTA) that considers the assessment of the webs and lower flange separately.

The testing and assessment of the solid beam sections must be carried out in accordance with section 2.3. of the ASFP Yellow Book - Test and assessment procedures - passive (non-reactive) fire protection systems.

SECTION FACTOR

The method of calculating the section factor for cellular beams with apertures is treated in a different manner than in the case of solid and hollow steel sections, because for any beam with closely spaced openings failure in fire will in most cases be caused by failure of the steel web. It is therefore important that the steel web temperature needs to be controlled. Moreover, the method of calculating the section factor must be suitable for symmetric and asymmetric beams fabricated from hot rolled sections and for beams fabricated from steel plate. Asymmetric steel beams may have different flange widths top and bottom. The position of the aperture may not be centrally located within the web of the beam.

Where a limiting temperature of 450°C has been provided, or one associated with a particular design of cellular beam provided by a qualified structural engineer in accordance with the principles given in the ASFP Yellow Book, the section factor for that beam shall be determined as the highest value derived from the following:

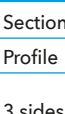
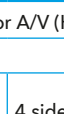


- a) The section factor of the 'T' section above the opening
- b) The section factor of the 'T' section below the opening
- c) The section factor derived from $1400/t_w$ where t_w is the thickness of the web in mm.

In all cases the thickness of protection obtained based on the section factor and temperature as derived above shall be increased by 20%. The applied thickness shall not exceed the maximum assessed for the product for beam protection.

In order to apply the thickness modification factor of +20% it is necessary to ascertain that the factor is appropriate or conservative. In order to determine this, testing shall be carried out in accordance with the test protocol described in section 4.2.1. of the ASFP Yellow Book 5th edition 2014.

The following tables are extracted from Section 6 of the ASFP Yellow Book publication 'Fire Protection for Structural Steel in Buildings. For the latest information, the current E-version should be checked at www.asfp.org.uk

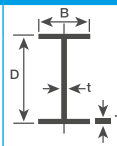
A/V Tables for Steelwork Encasements

Table 3a UK BEAMS (UKB)							Section factor A/V (Hp/A)			
Dimensions to BS4: Part 1: 2005							Profile			
							3 sides		4 sides	
Designation		Depth of section D	Width of section B	Thickness		Area of section A				
Serial size	Mass			Web t	Flange T		3 sides	4 sides	3 sides	4 sides
mm	kg/m	mm	mm	mm	mm	cm ²	m ⁻¹	m ⁻¹	m ⁻¹	m ⁻¹
1016 x 305	487	1036.1	308.5	30.0	54.1	619.89	45	50	40	45
	438	1025.9	305.4	26.9	49.0	556.62	50	55	40	50
	393	1016.0	303.0	24.4	43.9	500.24	55	65	45	55
	349	1008.1	302.0	21.1	40.0	445.15	65	70	50	60
	314	1000.0	300.0	19.1	35.9	400.41	70	80	55	65
	272	990.1	300.0	16.5	31.0	346.86	80	90	65	75
	249	980.2	300.0	16.5	26.0	316.88	90	95	70	80
	222	970.3	300.0	16.0	21.1	282.82	95	110	80	90
914 x 419	388	921.0	420.5	21.4	36.6	494.22	60	70	45	55
	343	911.8	418.5	19.4	32.0	437.30	70	80	50	60
914 x 305	289	926.6	307.7	19.5	32.0	368.27	75	80	60	65
	253	918.4	305.5	17.3	27.9	322.83	85	95	65	75
	224	910.4	304.1	15.9	23.9	285.64	95	105	75	85
	201	903.0	303.3	15.1	20.2	255.92	105	115	80	95
838 x 292	226	850.9	293.8	16.1	26.8	288.56	85	100	70	80
	194	840.7	292.4	14.7	21.7	246.82	100	115	80	90
	176	834.9	291.7	14.0	18.8	224.02	110	125	90	100
762 x 267	197	769.8	268.0	15.6	25.4	250.64	90	100	70	85
	173	762.2	266.7	14.3	21.6	220.37	105	115	80	95
	147	754.0	265.2	12.8	17.5	187.19	120	135	95	110
	134	750.0	264.4	12.0	15.5	170.58	130	145	105	120
686 x 254	170	692.9	255.8	14.5	23.7	216.83	95	110	75	90
	152	687.5	254.5	13.2	21.0	194.08	105	120	85	95
	140	683.5	253.7	12.4	19.0	178.43	115	130	90	105
	125	677.9	253.0	11.7	16.2	159.48	130	145	100	115
610 x 305	238	635.8	311.4	18.4	31.4	303.33	70	80	50	60
	179	620.2	307.1	14.1	23.6	228.08	90	105	70	80
	149	612.4	304.8	11.8	19.7	190.04	110	125	80	95
610 x 229	140	617.2	230.2	13.1	22.1	178.19	105	120	80	95
	125	612.2	229.0	11.9	19.6	159.34	115	130	90	105
	113	607.6	228.2	11.1	17.3	143.94	130	145	100	115
	101	602.6	227.6	10.5	14.8	128.92	145	160	110	130
610 x 178	100	607.4	179.2	11.3	17.2	128.00	135	150	110	125
	92	603.0	178.8	10.9	15.0	117.00	145	160	120	135
	82	598.6	177.9	10.0	12.8	104.00	160	180	130	150
533 x 312	273	577.1	320.2	21.1	37.6	348.00	60	70	40	50
	219	560.3	317.4	18.3	29.2	279.00	70	85	50	65
	182	550.7	314.5	15.2	24.4	231.00	85	100	60	75
	151	542.5	312.0	12.7	20.3	192.00	105	120	75	90
533 x 210	138	549.1	213.9	14.7	23.6	176.00	95	110	75	85
	122	544.5	211.9	12.7	21.3	155.39	110	120	85	95
	109	539.5	210.8	11.6	18.8	138.86	120	135	95	110
	101	536.7	210.0	10.8	17.4	128.67	130	145	100	115
	92	533.1	209.3	10.1	15.6	117.38	140	160	110	125
	82	528.3	208.8	9.6	13.2	104.69	155	175	120	140

Continued overleaf

Table 3b UK Beams (UKB)							Section factor A/V (Hp/A)			
Dimensions to BS4: Part 1: 2005							Profile			
							3 sides		4 sides	
Designation		Depth of section D	Width of section B	Thickness		Area of section A	Box			
Serial size	Mass			Web t	Flange T		3 sides	4 sides	3 sides	4 sides
mm	kg/m	mm	mm	mm	mm	cm ²	m ⁻¹	m ⁻¹	m ⁻¹	m ⁻¹
533 x 165	85	534.9	166.5	10.3	16.5	108.00	140	155	115	130
	75	529.1	165.9	9.7	13.6	95.20	160	175	130	145
	66	524.7	165.1	8.9	11.4	83.70	180	200	145	165
457 x 191	161	492.0	199.4	18.0	32.0	206.00	75	85	60	65
	133	480.6	196.7	15.3	26.3	170.00	90	100	70	80
	106	469.2	194.0	12.6	20.6	135.00	110	125	85	100
	98	467.2	192.8	11.4	19.6	125.26	120	135	90	105
	89	463.4	191.9	10.5	17.7	113.76	130	145	100	115
	82	460.0	191.3	9.9	16.0	104.48	140	160	105	125
	74	457.0	190.4	9.0	14.5	94.63	155	175	115	135
	67	453.4	189.9	8.5	12.7	85.51	170	190	130	150
457 x 152	82	465.8	155.3	10.5	18.9	104.53	130	145	105	120
	74	462.0	154.4	9.6	17.0	94.48	145	160	115	130
	67	458.0	153.8	9.0	15.0	85.55	155	175	125	145
	60	454.6	152.9	8.1	13.3	76.23	175	195	140	160
	52	449.8	152.4	7.6	10.9	66.64	200	220	160	180
406 x 178	85	417.2	181.9	10.9	18.2	109.00	125	140	95	110
	74	412.8	179.5	9.5	16.0	94.51	140	160	105	125
	67	409.4	178.8	8.8	14.3	85.54	155	175	115	140
	60	406.4	177.9	7.9	12.8	76.52	170	195	130	155
	54	402.6	177.7	7.7	10.9	68.95	190	215	145	170
406 x 140	53	406.6	143.3	7.9	12.9	67.90	180	200	140	160
	46	403.2	142.2	6.8	11.2	58.64	205	230	160	185
	39	398.0	141.8	6.4	8.6	49.65	240	270	190	215
356 x 171	67	363.4	178.1	9.1	15.7	85.49	140	160	105	125
	57	358.0	172.2	8.1	13.0	72.55	165	190	120	145
	51	355.0	171.5	7.4	11.5	64.91	185	210	135	160
	45	351.4	171.1	7.0	9.7	57.33	205	235	150	180
356 x 127	39	353.4	126.0	6.6	10.7	49.77	210	235	165	195
	33	349.0	125.4	6.0	8.5	42.13	250	280	195	225
305 x 165	54	310.4	166.9	7.9	13.7	68.77	160	185	115	140
	46	306.6	165.7	6.7	11.8	58.75	185	210	135	160
	40	303.4	165.0	6.0	10.2	51.32	210	240	150	185
305 x 127	48	311.0	125.3	9.0	14.0	61.23	160	180	120	145
	42	307.2	124.3	8.0	12.1	53.40	180	200	140	160
	37	304.4	123.4	7.1	10.7	47.18	200	225	155	180
305 x 102	33	312.7	102.4	6.6	10.8	41.83	215	240	175	200
	28	308.7	101.8	6.0	8.8	35.88	250	280	200	230
	25	305.1	101.6	5.8	7.0	31.60	280	315	225	255
254 x 146	43	259.6	147.3	7.2	12.7	54.77	170	195	120	150
	37	256.0	146.4	6.3	10.9	47.16	195	225	140	170
	31	251.4	146.1	6.0	8.6	39.68	230	270	165	200
254 x 102	28	260.4	102.2	6.3	10.0	36.08	220	250	175	200
	25	257.2	101.9	6.0	8.4	32.04	250	280	190	225
	22	254.0	101.6	5.7	6.8	28.02	280	320	220	255

Table 3c UK Beams (UKB)							Section factor A/V (Hp/A)			
Dimensions to BS4: Part 1: 2005							Profile			
							3 sides		4 sides	
Designation		Depth of section D	Width of section B	Thickness		Area of section A	3 sides		4 sides	
Serial size	Mass			Web t	Flange T		3 sides	4 sides	3 sides	4 sides
mm	kg/m	mm	mm	mm	mm	cm ²	m ⁻¹	m ⁻¹	m ⁻¹	m ⁻¹
203 x 133	30	206.8	133.9	6.4	9.6	38.21	205	240	145	180
	25	203.2	133.2	5.7	7.8	31.97	245	285	170	210
203 x 102	23	203.2	101.8	5.4	9.3	29.40	235	270	175	205
178 x 102	19	177.8	101.2	4.8	7.9	24.26	260	305	190	230
152 x 89	16	152.4	88.7	4.5	7.7	20.32	270	315	195	235
127 x 76	13	127.0	76.0	4.0	7.6	16.52	280	325	200	245



Note: Data on older and other steel sizes can be found on ASFP website/technical section (www.asfp.org.uk)

Table 3d UK Columns (UKC)							Section factor A/V (Hp/A)			
Dimensions to BS4: Part 1: 2005							Profile			
							3 sides		4 sides	
Designation		Depth of section D	Width of section B	Thickness		Area of section A	Box			
Serial size	Mass			Web t	Flange T		3 sides	4 sides	3 sides	4 sides
mm	kg/m	mm	mm	mm	mm	cm ²	m ⁻¹	m ⁻¹	m ⁻¹	m ⁻¹
356 x 406	634	474.6	424.0	47.6	77.0	807.55	25	30	15	20
	551	455.6	418.5	42.1	67.5	701.93	30	35	20	25
	467	436.6	412.2	35.8	58.0	594.91	35	40	20	30
	393	419.0	407.0	30.6	49.2	500.57	40	50	25	35
	340	406.4	403.0	26.6	42.9	433.04	45	55	30	35
	287	393.6	399.0	22.6	36.5	365.71	50	65	30	45
	235	381.0	394.8	18.4	30.2	299.43	65	75	40	50
356 x 368	202	374.6	374.7	16.5	27.0	257.22	70	85	45	60
	177	368.2	372.6	14.4	23.8	225.52	80	95	50	65
	153	362.0	370.5	12.3	20.7	194.80	90	110	55	75
	129	355.6	368.6	10.4	17.5	164.31	110	130	65	90
305 x 305	283	365.3	322.2	26.8	44.1	360.41	45	55	30	40
	240	352.5	318.4	23.0	37.7	305.79	50	60	35	45
	198	339.9	314.5	19.1	31.4	252.41	60	75	40	50
	158	327.1	311.2	15.8	25.0	201.36	75	90	50	65
	137	320.5	309.2	13.8	21.7	174.41	85	105	55	70
	118	314.5	307.4	12.0	18.7	150.20	100	120	60	85
	97	307.9	305.3	9.9	15.4	123.45	120	145	75	100
254 x 254	167	289.1	265.2	19.2	31.7	212.85	60	75	40	50
	132	276.3	261.3	15.3	25.3	168.13	75	90	50	65
	107	266.7	258.8	12.8	20.5	136.38	95	110	60	75
	89	260.3	256.3	10.3	17.3	113.31	110	135	70	90
	73	254.1	254.6	8.6	14.2	93.10	130	160	80	110
203 x 203	127	241.4	213.9	18.1	30.1	162.00	65	80	45	55
	113	235.0	212.1	16.3	26.9	145.00	75	90	45	60
	100	228.6	210.3	14.5	23.7	127.00	80	100	55	70
	86	222.2	209.1	12.7	20.5	109.64	95	115	60	80
	71	215.8	206.4	10.0	17.3	90.43	110	135	70	95
	60	209.6	205.8	9.4	14.2	76.37	130	160	80	110
	52	206.2	204.3	7.9	12.5	66.28	150	180	95	125
	46	203.2	203.6	7.2	11.0	58.73	170	200	105	140
152 x 152	51	170.2	157.4	11.0	15.7	65.20	120	145	75	100
	44	166.0	155.9	9.5	13.6	56.10	135	165	85	115
	37	161.8	154.4	8.0	11.5	47.11	160	195	100	135
	30	157.6	152.9	6.5	9.4	38.26	195	235	120	160
	23	152.4	152.2	5.8	6.8	29.24	250	305	155	210





Table 3e Joists (UKJ)							Section factor A/V (Hp/A)					
Dimensions to BS4: Part 1:1993							Profile				Box	
							3 sides		4 sides		3 sides	4 sides
Designation		Depth of section D	Width of section B	Thickness		Area of section A						
Serial size	Mass			Web t	Flange T				m ⁻¹	m ⁻¹	m ⁻¹	m ⁻¹
mm	kg/m	mm	mm	mm	mm	cm ²	m ⁻¹	m ⁻¹	m ⁻¹	m ⁻¹		
203 x 152	52.3	203.2	152.4	8.9	16.5	66.6	115	140	85	105		
152 x 127	37.3	152.4	127.0	10.4	13.2	47.5	130	155	90	120		









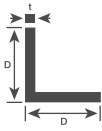
Table 3f PARALLEL FLANGE CHANNELS (PFC)							Section factor A/V (Hp/A)							
Dimensions to BS4 Part 1: 2005							Profile				Box			
							3 sides		3 sides		3 sides		4 sides	
Designation		Depth of section D	Width of section B	Thickness		Area of section A								
Serial size	Mass			Web t	Flange T				m ⁻¹	m ⁻¹	m ⁻¹	m ⁻¹	m ⁻¹	m ⁻¹
mm	kg/m	mm	mm	mm	mm	cm ²	m ⁻¹	m ⁻¹	m ⁻¹	m ⁻¹	m ⁻¹	m ⁻¹	m ⁻¹	
430 x 100	64.40	430	100	11.0	19.0	82.09	135	95	75	150	115	75	75	130
380 x 100	54.00	380	100	9.5	17.5	68.74	150	110	85	165	125	85	85	140
300 x 100	45.50	300	100	9.0	16.5	58.00	150	115	85	165	120	85	85	140
300 x 90	41.40	300	90	9.0	15.5	52.78	160	120	90	175	130	90	90	150
260 x 90	34.80	260	90	8.0	14.0	44.38	170	135	100	190	135	100	100	160
260 x 75	27.60	260	75	7.0	12.0	35.14	205	150	115	225	170	115	115	190
230 x 90	32.20	230	90	7.5	14.0	40.97	170	140	100	195	135	100	100	155
230 x 75	25.70	230	75	6.5	12.5	32.69	200	155	115	225	165	115	115	185
200 x 90	29.70	200	90	7.0	14.0	37.86	170	140	100	195	130	100	100	155
200 x 75	23.40	200	75	6.0	12.5	29.87	200	160	115	225	160	115	115	185
180 x 90	26.10	180	90	6.5	12.5	33.19	185	155	110	210	135	110	110	165
180 x 75	20.30	180	75	6.0	10.5	25.91	215	175	125	245	170	125	125	195
150 x 90	23.90	150	90	6.5	12.0	30.41	180	160	110	210	130	110	110	160
150 x 75	17.90	150	75	5.5	10.0	22.77	220	190	130	255	165	130	130	200
125 x 65	14.80	125	65	5.5	9.5	18.80	225	195	135	260	170	135	135	200
100 x 50	10.20	100	50	5.0	8.5	13.00	255	215	155	295	190	155	155	230

Table 3g Equal Angles (UKA)				Section factor A/V (Hp/A)					
Dimensions to BS EN 10056-1:1999				Profile			Box		
Designation	Serial size D x D	Thickness t		Mass	Area of section A	3 sides	3 sides	4 sides	3 sides
mm	mm	kg/m	cm ²	m ⁻¹	m ⁻¹	m ⁻¹	m ⁻¹	m ⁻¹	m ⁻¹
200 x 200	24	71.1	90.6	65	85	85	65	90	
	20	59.9	76.3	75	100	105	80	105	
	18	54.2	69.1	85	110	115	85	115	
	16	48.5	61.8	95	125	125	95	130	
150 x 150	18	40.1	51.0	85	110	115	90	120	
	15	33.8	43.0	100	135	135	105	140	
	12	27.3	34.8	125	165	170	130	170	
	10	23.0	29.3	150	195	200	155	205	
120 x 120	15	26.6	33.9	105	135	140	105	140	
	12	21.6	27.5	125	165	170	130	175	
	10	18.2	23.2	150	200	200	155	205	
	8	14.7	18.7	185	245	250	190	255	
100 x 100	15	21.9	27.9	105	135	140	110	145	
	12	17.8	22.7	130	165	170	130	175	
	10	15.0	19.2	150	200	205	155	210	
	8	12.2	15.5	185	245	250	195	260	
90 x 90	12	15.9	20.3	130	165	175	135	175	
	10	13.4	17.1	150	200	205	160	210	
	8	10.9	13.9	190	245	250	195	260	
	7	9.6	12.2	215	280	285	220	295	

A/V Tables for Steelwork Encasements

Table 3h Equal Angles (UKA)				Section factor A/V (Hp/A)									
Dimensions to BS EN 10056-1: 1999				Profile									
				3 sides					4 sides				
Designation		Mass	Area of section A	3 sides		4 sides		3 sides		4 sides			
Size D x B	Thickness t			m ⁻¹	m ⁻¹	m ⁻¹	m ⁻¹	m ⁻¹	m ⁻¹	m ⁻¹	m ⁻¹		
mm	mm	kg/m	cm ²	m ⁻¹	m ⁻¹	m ⁻¹	m ⁻¹	m ⁻¹	m ⁻¹	m ⁻¹	m ⁻¹	m ⁻¹	m ⁻¹
200 x 150	18	47.1	60.0	115	115	90	80	115	90	85	90	85	115
	15	39.6	50.5	135	135	105	95	135	110	100	110	100	140
	12	32.0	40.8	165	165	130	120	170	135	125	135	125	170
200 x 100	15	33.7	43.0	135	135	115	90	135	115	95	115	95	140
	12	27.3	34.8	165	165	140	110	170	145	115	145	115	170
	10	23.0	29.2	200	200	165	130	200	170	135	170	135	205
150 x 90	15	26.6	33.9	135	135	110	95	140	115	95	115	95	140
	12	21.6	27.5	170	170	140	115	170	140	120	140	120	175
	10	18.2	23.2	200	200	165	140	205	170	145	170	145	205
150 x 75	15	24.8	31.7	135	135	115	90	140	120	95	120	95	140
	12	20.2	25.7	170	170	140	115	170	145	115	145	115	175
	10	17.0	21.7	200	200	170	135	205	175	140	175	140	210
125 x 75	12	17.8	22.7	170	170	140	115	170	145	120	145	120	175
	10	15.0	19.1	200	200	165	140	205	170	145	170	145	210
	8	12.2	15.5	250	250	205	170	250	210	180	210	180	260
100 x 75	12	15.4	19.7	170	170	135	125	175	140	125	140	125	180
	10	13.0	16.6	205	205	160	145	205	165	150	165	150	210
	8	10.6	13.5	250	250	200	180	255	205	185	205	185	260
100 x 65	10	12.3	15.6	205	205	165	140	205	170	145	170	145	210
	8	9.9	12.7	250	250	200	175	255	210	180	210	180	260
	7	8.8	11.2	285	285	230	200	290	235	205	235	205	295

Note: Data on older and other steel sizes can be found on ASFP website/technical section (www.asfp.org.uk)

Table 3i STRUCTURAL Tees (UKT) Split from UK Beams						Section factor A/V (Hp/A)					
Dimensions to BS4: Part 1: 2005						Profile			Box		
						3 sides	3 sides	4 sides	3 sides	3 sides	4 sides
Serial size	Mass	Width of section B	Depth of section D	Web Thickness t	Area of section A						
mm	kg/m	mm	mm	mm	cm ²	m ⁻¹	m ⁻¹	m ⁻¹	m ⁻¹	m ⁻¹	m ⁻¹
254 x 343	62.6	253.0	338.9	11.7	79.73	115	145	145	115	115	150
305 x 305	119.0	311.4	317.9	18.4	152	60	80	80	60	60	85
	89.5	307.1	310.0	14.1	114.03	80	105	105	80	80	110
	74.6	304.8	306.1	11.8	95.01	95	125	125	95	95	130
229 x 305	69.9	230.2	308.5	13.1	89.08	95	120	120	95	95	120
	62.5	229.0	306.0	11.9	79.66	105	130	135	105	105	135
	56.5	228.2	303.7	11.1	71.96	115	145	145	115	115	150
	50.6	227.6	301.2	10.5	64.45	125	160	160	130	130	165
178 x 305	50.1	179.2	303.7	11.3	63.90	120	150	150	125	125	150
	46.1	178.8	301.5	10.9	58.70	130	160	160	135	135	165
	40.9	177.9	299.3	10.0	52.10	145	180	180	150	150	185
312 x 267	136.7	320.2	288.8	21.1	174	50	70	70	50	50	70
	109.4	317.4	280.4	18.3	139	60	85	85	65	65	85
	90.7	314.5	275.6	15.2	116	75	100	100	75	75	100
	75.3	312.0	271.5	12.7	95.90	90	120	120	90	90	120
210 x 267	69.1	213.9	274.5	14.7	23.60	85	110	110	85	85	110
	61.0	211.9	272.2	12.7	77.69	95	125	125	95	95	125
	54.5	210.8	269.7	11.6	69.43	105	135	135	110	110	140
	50.5	210.0	268.3	10.8	64.33	115	145	145	115	115	150
	46.0	209.3	266.5	10.1	58.68	125	160	160	125	125	160
	41.1	208.8	264.1	9.6	52.34	140	175	180	140	140	180
165 x 267	42.3	166.5	267.1	10.3	54.0	130	155	160	130	130	160
	37.4	165.9	264.5	9.7	47.6	145	175	180	145	145	180
	32.8	165.1	262.4	8.9	41.9	160	200	200	165	165	205
191 x 229	80.7	199.4	246.0	18.0	103	65	85	85	65	65	85
	66.6	196.7	240.3	15.3	84.9	80	100	100	80	80	105
	52.9	194.0	234.6	12.6	67.4	95	125	125	100	100	125
	49.1	192.8	233.5	11.4	62.62	105	135	135	105	105	135
	44.6	191.9	231.6	10.5	58.87	115	145	145	115	115	150
	41.0	191.3	229.9	9.9	52.23	125	160	160	125	125	160
	37.1	190.4	228.4	9.0	47.31	135	175	175	135	135	175
	33.5	189.9	226.6	8.5	42.75	150	190	195	150	150	195
152 x 229	41.0	155.3	232.8	10.5	52.26	115	145	145	120	120	150
	37.1	154.4	230.9	9.6	47.23	130	160	160	130	130	165
	33.6	153.8	228.9	9.0	42.77	140	175	175	145	145	180


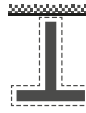










Table 3j STRUCTURAL Tees (UKT) Split from UK Beams						Section factor A/V (Hp/A)					
Dimensions to BS4: Part 1: 2005						Profile			Box		
						3 sides	3 sides	4 sides	3 sides	3 sides	4 sides
Serial size	Mass	Width of section B	Depth of section D	Web Thickness t	Area of section A						
mm	kg/m	mm	mm	mm	cm ²	m ⁻¹	m ⁻¹	m ⁻¹	m ⁻¹	m ⁻¹	m ⁻¹
152 x 229	29.9	152.9	227.2	8.1	38.11	155	195	195	160	160	200
	26.1	152.4	224.8	7.6	33.31	180	220	225	180	180	225
178 x 203	42.6	181.9	208.6	10.9	54.30	110	140	140	110	110	145
	37.1	179.5	206.3	9.5	47.24	125	160	160	125	125	165
	33.5	178.8	204.6	8.8	42.76	135	175	175	140	140	180
	30.0	177.9	203.1	7.9	38.25	150	195	195	155	155	200
	27.0	177.7	201.2	7.7	34.47	165	215	215	170	170	220
140 x 203	26.6	143.3	203.3	7.9	34.0	160	200	200	160	160	205
	23.0	142.2	201.5	6.8	29.31	185	230	230	185	185	235
	19.5	141.8	198.9	6.4	24.82	215	270	270	215	215	275
171 x 178	33.5	173.2	181.6	9.1	42.74	125	160	165	125	125	165
	28.5	172.2	178.9	8.1	36.27	145	190	190	145	145	195
	25.5	171.5	177.4	7.4	32.44	160	210	210	160	160	215
	22.5	171.1	175.6	7.0	28.66	180	235	240	180	180	240
127 x 178	19.5	126.0	176.6	6.6	24.88	190	235	240	195	195	245
	16.5	125.4	174.4	6.0	21.06	220	280	280	225	225	285
165 x 152	27.0	166.9	155.1	7.9	34.38	135	185	185	140	140	185
	23.0	165.7	153.2	6.7	29.37	160	210	215	160	160	215
	20.1	165.0	151.6	6.0	25.65	180	240	245	185	185	245
127 x 152	24.0	125.3	155.4	9.0	30.61	140	180	180	140	140	185
	20.9	124.3	153.5	8.0	26.69	160	200	205	160	160	210
	18.5	123.4	152.1	7.1	23.58	180	225	230	180	180	235
102 x 152	16.4	102.4	156.3	6.6	20.91	195	240	245	200	200	245
	14.1	101.8	154.3	6.0	17.93	225	280	280	230	230	285
	12.4	101.6	152.5	5.8	15.80	255	315	320	255	255	320
146 x 127	21.5	147.3	129.7	7.2	27.38	145	195	200	150	150	200
	18.5	146.4	127.9	6.3	23.58	170	225	230	170	170	235
	15.5	146.1	125.6	6.0	19.83	195	270	270	200	200	275
102 x 127	14.1	102.2	130.1	6.3	18.03	195	250	255	200	200	260
	12.6	101.9	128.5	6.0	16.01	220	280	285	225	225	290
	11.0	101.6	126.9	5.7	14.00	250	320	320	255	255	325
133 x 102	15.0	133.9	103.3	6.4	19.10	175	240	245	180	180	250
	12.5	133.2	101.5	5.7	15.98	205	285	290	210	210	295

Table 3k Structural Tees Split from UK columns (UKT)						Section factor A/V (Hp/A)					
						Profile			Box		
Dimensions to BS4 Part 1: 2005						3 sides	3 sides	4 sides	3 sides	3 sides	4 sides
Serial size	Mass	Width of section B	Depth of section D	Web Thickness t	Area of section A						
mm	kg/m	mm	mm	mm	cm ²	m ⁻¹	m ⁻¹	m ⁻¹	m ⁻¹	m ⁻¹	m ⁻¹
305 x 152	79.0	311.2	163.5	15.8	100.67	60	90	95	65	65	95
	68.4	309.2	160.2	13.8	87.20	70	105	105	70	70	110
	58.9	307.4	157.2	12.0	75.10	80	120	120	85	85	125
	48.4	305.3	153.9	9.9	61.72	95	145	145	100	100	150
254 x 127	83.5	265.2	144.5	19.2	106	50	75	75	50	50	75
	66.0	261.3	138.1	15.3	84.06	65	90	95	65	65	95
	53.5	258.8	133.3	12.8	68.18	75	110	115	75	75	115
	44.4	256.3	130.1	10.3	56.65	90	135	135	90	90	135
	36.5	254.6	127.0	8.6	46.55	105	160	160	110	110	165
203 x 102	63.7	213.9	120.7	18.1	81.2	55	80	80	55	55	80
	56.7	212.1	117.5	16.3	72.3	60	90	90	60	60	90
	49.8	210.3	114.3	14.5	63.4	70	100	100	70	70	100
	43.0	209.1	111.0	12.7	54.81	75	115	115	80	80	115
	35.5	206.4	107.8	10.0	45.20	90	135	135	95	95	140
	30.0	205.8	104.7	9.4	38.18	105	160	160	110	110	165
	26.0	204.3	103.0	7.9	33.13	120	180	185	125	125	185
	23.0	203.6	101.5	7.2	29.36	135	200	205	140	140	210
152 x 76	25.6	157.4	85.1	11.0	32.6	100	145	145	100	100	150
	22.0	155.9	83.0	9.5	28.0	110	165	170	115	115	170
	18.5	154.4	80.8	8.0	23.55	130	195	195	135	135	200
	15.0	152.9	78.7	6.5	19.12	160	235	240	160	160	240
	11.5	152.2	76.1	5.8	14.62	205	305	310	210	210	310

ROLLED TEES

Note: Whilst the ASFP publication has previously included listings for four sizes of 'rolled tees' we are informed by Corus Construction and Industrial Division that 'rolled tees' are no longer available from their current manufacturing facilities.

A/V Tables for Steelwork Encasements

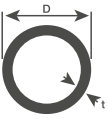
Table 3l Circular Hollow Sections (CHS)			Section factor A/V (Hp/A)		
Dimensions to EN 10210 S355J2H			Profile or box		
Outside diameter D	Wall thickness t	Mass	Area of section A	m ⁻¹	
mm	mm	kg/m	cm ²	m ⁻¹	m ⁻¹
21.3	2.6	1.20	1.53	440	440
	2.9	1.32	1.68	400	400
	3.2	1.43	1.82	370	370
26.9	2.6	1.56	1.98	425	425
	2.9	1.72	2.19	385	385
	3.2	1.87	2.38	355	355
33.7	2.6	1.99	2.54	415	415
	2.9	2.20	2.81	375	375
	3.2	2.41	3.07	345	345
	3.6	2.67	3.40	310	310
	4.0	2.93	3.73	285	285
42.4	2.6	2.55	3.25	410	410
	2.9	2.82	3.60	370	370
	3.2	3.09	3.94	340	340
	3.6	3.44	4.39	305	305
	4.0	3.79	4.83	275	275
48.3	2.9	3.25	4.14	365	365
	3.2	3.56	4.53	335	335
	3.6	3.97	5.06	300	300
	4.0	4.37	5.57	270	270
	5.0	5.34	6.80	225	225
60.3	2.9	4.11	5.23	360	360
	3.2	4.51	5.74	330	330
	3.6	5.03	6.41	295	295
	4.0	5.55	7.07	270	270
	5.0	6.82	8.69	220	220
76.1	2.9	5.24	6.67	358	358
	3.2	5.75	7.33	325	325
	3.6	6.44	8.20	290	290
	4.0	7.11	9.06	265	265
	5.0	8.77	11.2	215	215
88.9	2.9	6.15	7.84	355	355
	3.2	6.76	8.62	325	325
	3.6	7.57	9.65	290	290
	4.0	8.38	10.7	260	260
	5.0	10.3	13.2	210	210
6.3	12.8	16.3	170	170	

Table 3m Circular Hollow Sections (CHS)			Section factor A/V (Hp/A)		
Dimensions to EN 10210 S355J2H			Profile or box		
Outside diameter D	Wall thickness t	Mass	Area of section A	m ⁻¹	
mm	mm	kg/m	cm ²	m ⁻¹	m ⁻¹
114.3	3.2	8.77	11.2	320	320
	3.6	9.83	12.5	285	285
	4.0	10.9	13.9	260	260
	5.0	13.5	17.2	210	210
139.7	6.3	16.8	21.4	170	170
	3.2	10.8	13.7	320	320
	3.6	12.1	15.4	285	285
	4.0	13.4	17.1	255	255
168.3	5.0	16.6	21.2	205	205
	6.3	20.7	26.4	165	165
	8.0	26.0	33.1	135	135
	10.0	32.0	40.7	110	110
	12.5	48.0	61.2	85	85
193.7	5.0	20.1	25.7	205	205
	6.3	25.2	32.1	165	165
	8.0	31.6	40.3	130	130
	10.0	39.0	49.7	105	105
	12.5	55.9	71.2	85	85
219.1	5.0	23.3	29.6	205	205
	6.3	29.1	37.1	165	165
	8.0	36.6	46.7	130	130
	10.0	45.3	57.7	105	105
	12.5	55.9	71.2	85	85
	14.2	71.8	91.4	75	75
244.5	16.0	80.1	102	65	65
	5.0	29.5	37.6	205	205
	6.3	37.0	47.1	165	165
	8.0	46.7	59.4	130	130
	10.0	57.8	73.7	105	105
273	12.5	71.5	91.1	85	85
	14.2	80.6	103	75	75
	16.0	90.2	115	65	65
	5.0	33.0	42.1	205	205
	6.3	41.4	52.8	160	160
8.0	52.3	66.6	130	130	
10.0	64.9	82.6	105	105	

Table continued overleaf

Chapter 3: Structural Steel

A/V Tables for Steelwork Encasements

Table 3n Circular Hollow Sections (CHS) Dimensions to EN 10210 S355J2H				Section factor A/V (Hp/A)	
Outside diameter D	Wall thickness t	Mass	Area of section A	Profile or box	
mm	mm	kg/m	cm ²	m ⁻¹	m ⁻¹
273	12.5	80.3	102	85	85
	14.2	90.6	115	75	75
	16.0	101	129	65	65
323.9	5.0	39.3	50.1	205	205
	6.3	49.3	62.9	160	160
	8.0	62.3	79.4	130	130
	10.0	77.4	98.6	105	105
	12.5	96.0	122	85	85
	14.2	108	138	75	75
	16.0	121	155	65	65
355.6	6.3	54.3	69.1	160	160
	8.0	68.6	87.4	130	130
	10.0	85.2	109	100	100
	12.5	106	135	85	85
	14.2	120	152	75	75
	16.0	134	171	65	65
406.4	6.3	62.2	79.2	160	160
	8.0	78.6	100	130	130
	10.0	97.8	125	100	100
	12.5	121	155	80	80
	14.2	137	175	75	75
	16.0	154	196	65	65
457	6.3	70	89.2	160	160
	8.0	88.6	113	130	130
	10.0	110	140	105	105
	12.5	137	175	80	80
	14.2	155	198	75	75
	16.0	174	222	65	65
508.0	6.3	77.9	99.3	160	160
	8.0	98.6	126	125	125
	10.0	123	156	100	100
	12.5	153	195	80	80
	14.2	173	220	75	75
	16.0	194	247	65	65

Note: Data on older and other steel sizes can be found on ASFP website/technical section (www.asfp.org.uk)

A/V Tables for Steelwork Encasements

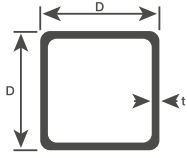
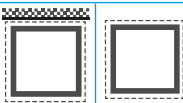
Table 3o Square Hollow Sections (SHS)				Section factor A/V (Hp/A)	
Dimensions to EN 10210 S355J2H				3 sides	4 sides
Designation		Mass	Area of section A		
Size D x D	Wall thickness t			m ⁻¹	m ⁻¹
mm	mm	kg/m	cm ²	m ⁻¹	m ⁻¹
40 x 40	3.0	3.41	4.34	275	370
	3.2	3.61	4.60	260	350
	3.6	4.01	5.10	235	315
	4.0	4.39	5.59	215	290
	5.0	5.28	6.73	180	240
50 x 50	3.0	4.35	5.54	270	365
	3.2	4.62	5.88	255	340
	3.6	5.14	6.54	230	305
	4.0	5.64	7.19	210	280
	5.0	6.85	8.73	175	230
60 x 60	3.0	5.29	6.74	270	360
	3.2	5.62	7.16	250	335
	3.6	6.27	7.98	225	300
	4.0	6.90	8.79	205	275
	5.0	8.42	10.7	170	225
70 x 70	3.0	6.24	7.94	265	355
	3.2	6.63	8.44	250	335
	3.6	7.40	9.42	225	300
	4.0	8.15	10.4	205	270
	5.0	9.99	12.7	165	220
80 x 80	3.0	7.18	9.14	265	350
	3.2	7.63	9.72	250	330
	3.6	8.53	10.9	220	295
	4.0	9.41	12.0	200	270
	5.0	11.6	14.7	165	220
90 x 90	3.6	9.66	12.3	220	295
	4.0	10.7	13.6	200	265
	5.0	13.1	16.7	160	215
	6.3	16.2	20.7	130	175
	8.0	20.1	25.6	105	140

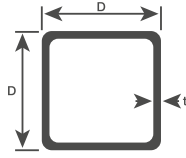
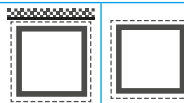
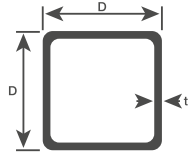
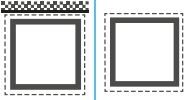
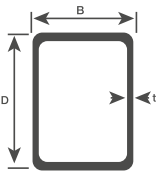
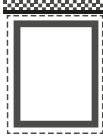

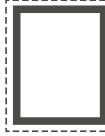
Table 3p Square Hollow Sections (SHS)				Section factor A/V (Hp/A)	
Dimensions to EN 10210 S355J2H				3 sides	4 sides
Designation		Mass	Area of section A		
Size D x D	Wall thickness t			m ⁻¹	m ⁻¹
mm	mm	kg/m	cm ²	m ⁻¹	m ⁻¹
100 x 100	3.6	10.8	13.7	220	295
	4.0	11.9	15.2	200	265
	5.0	14.7	18.7	160	215
	6.3	18.2	23.2	130	175
	8.0	22.6	28.8	105	140
	10.0	27.4	34.9	90	115
120 x 120	4.0	14.4	18.4	195	260
	5.0	17.8	22.7	160	215
	6.3	22.2	28.2	130	170
	8.0	27.6	35.2	105	140
	10.0	33.7	42.9	85	115
140 x 140	5.0	21.0	26.7	160	210
	6.3	26.1	33.3	130	170
	8.0	32.6	41.6	100	135
	10.0	40.0	50.9	85	110
	12.5	48.7	62.1	70	90
150 x 150	5.0	22.6	28.7	160	210
	6.3	28.1	35.8	125	170
	8.0	35.1	44.8	100	135
	10.0	43.1	54.9	85	110
	12.5	52.7	67.1	70	90
	16.0	65.2	83.0	55	75
160 x 160	5.0	24.1	30.7	160	210
	6.3	30.1	38.3	125	170
	8.0	37.6	48.0	100	135
	10.0	46.3	58.9	85	110
	12.5	56.6	72.1	70	90
	14.2	63.3	80.7	60	80
180 x 180	5.0	27.3	34.7	155	210
	6.3	34.0	43.3	125	170
	8.0	42.7	54.4	100	135
	10.0	52.5	66.9	80	110
	12.5	64.4	82.1	65	90
	14.2	72.2	92.0	60	80
16.0	80.2	102	55	70	

Table continued overleaf

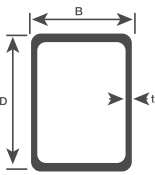
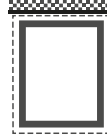

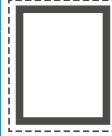
A/V Tables for Steelwork Encasements

Table 3q Square Hollow Sections (SHS)				Section factor A/V (Hp/A)	
Dimensions to EN 10210 S355J2H				3 sides	4 sides
Designation		Mass	Area of section A		
Size D x D	Wall thickness t			m ⁻¹	m ⁻¹
mm	mm	kg/m	cm ²	m ⁻¹	m ⁻¹
200 x 200	5.0	30.4	38.7	155	210
	6.3	38.0	48.4	125	165
	8.0	47.7	60.8	100	135
	10.0	58.8	74.9	85	110
	12.5	72.3	92.1	65	90
	14.2	81.1	103	60	80
	16.0	90.3	115	55	70
250 x 250	5.0	38.3	48.7	155	205
	6.3	47.9	61.0	125	165
	8.0	60.3	76.8	100	130
	10.0	74.5	94.9	80	105
	12.5	91.9	117	65	85
	14.2	103	132	60	75
	16.0	115	147	55	70
260 x 260	6.3	49.9	63.5	125	165
	8.0	62.8	80.0	100	130
	10.0	77.7	98.9	80	105
	12.5	95.8	122	65	85
	14.2	108	137	60	75
	16.0	120	153	55	70
300 x 300	6.3	57.8	73.6	125	165
	8.0	72.8	92.8	100	130
	10.0	90.2	115	80	105
	12.5	112	142	65	85
	14.2	126	160	60	75
	16.0	141	179	50	70
350 x 350	8.0	85.4	109	100	130
	10.0	106	135	80	105
	12.5	131	167	65	85
	14.2	148	189	55	75
	16.0	166	211	50	70
400 x 400	8.0	97.9	125	100	130
	10.0	122	155	80	105
	12.5	151	192	65	85
	14.2	170	217	55	75
	16.0	191	243	50	70
	20.0	235	300	40	55

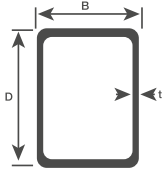
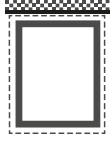
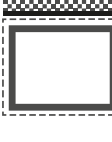
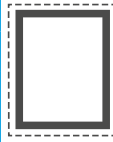
A/V Tables for Steelwork Encasements

Table 3r Rectangular Hollow Sections (RHS)				Section factor A/V (Hp/A)		
Dimensions to EN 10210 S355J2H				3 sides	3 sides	4 sides
Designation						
Size D x B	Wall thickness t	Mass	Area of section A			
mm	mm	kg/m	cm ²	m ⁻¹	m ⁻¹	m ⁻¹
50 x 30	3.0	3.41	4.34	300	255	370
	3.2	3.61	4.60	285	240	350
	3.6	4.01	5.10	255	215	315
	4.0	4.39	5.59	235	200	290
	5.0	5.28	6.73	195	165	240
60 x 40	3.0	4.35	5.54	290	255	365
	3.2	4.62	5.88	275	240	340
	3.6	5.14	6.54	245	215	305
	4.0	5.64	7.19	225	195	280
	5.0	6.85	8.73	185	160	230
	6.3	8.31	10.6	150	135	190
80 x 40	3.0	5.29	6.74	300	240	360
	3.2	5.62	7.16	280	225	335
	3.6	6.27	7.98	250	200	300
	4.0	6.90	8.79	230	185	275
	5.0	8.42	10.7	190	150	225
	6.3	10.3	13.1	155	125	185
	8.0	12.5	16.0	125	100	150
	90 x 50	3.0	6.24	7.94	290	240
3.2		6.63	8.44	275	225	335
3.6		7.40	9.42	245	205	300
4.0		8.15	10.4	225	185	270
5.0		9.99	12.7	185	150	220
6.3		12.3	15.6	150	125	180
8.0		15.0	19.2	120	100	150
100 x 50		3.0	6.71	8.54	295	235
	3.2	7.13	9.08	275	220	330
	3.6	7.96	10.1	250	200	300
	4.0	8.78	11.2	225	180	270
	5.0	10.8	13.7	185	150	220
	6.3	13.3	16.9	150	120	180
	8.0	16.3	20.8	120	100	145
	10.0	19.6	24.9	100	80	120
100 x 60	3.0	7.18	9.14	285	240	350
	3.2	7.63	9.72	270	230	330
	3.6	8.53	10.9	240	205	295
	4.0	9.41	12.0	220	185	270
	5.0	11.6	14.7	180	150	220
	6.3	14.2	18.1	145	125	180
	8.0	17.5	22.4	120	100	145

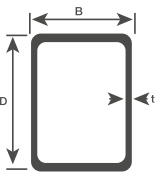
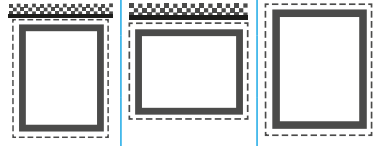
A/V Tables for Steelwork Encasements

Table 3s Rectangular Hollow Sections (RHS)				Section factor A/V (Hp/A)		
Dimensions to EN 10210 S355J2H				3 sides	3 sides	4 sides
Designation						
Size D x B	Wall thickness t	Mass	Area of section A			
mm	mm	kg/m	cm ²	m ⁻¹	m ⁻¹	m ⁻¹
120 x 60	3.6	9.66	12.3	245	195	300
	4.0	10.7	13.6	220	180	265
	5.0	13.1	16.7	180	145	215
	6.3	16.2	20.7	145	120	175
	8.0	20.1	25.6	120	95	140
	10.0	24.3	30.9	100	80	120
120 x 80	3.6	10.8	13.7	235	205	295
	4.0	11.9	15.2	210	185	265
	5.0	14.7	18.7	175	150	215
	6.3	18.2	23.2	140	120	175
	8.0	22.6	28.8	115	100	140
	10.0	27.4	34.9	95	80	115
150 x 100	4.0	15.1	19.2	210	185	260
	5.0	18.6	23.7	170	150	215
	6.3	23.1	29.5	135	120	170
	8.0	28.9	36.8	110	95	135
	10.0	35.3	44.9	90	80	115
	12.5	42.8	54.6	75	65	95
150 x 125	4.0	16.6	21.2	200	190	260
	5.0	20.6	26.2	165	155	210
	6.3	25.6	32.6	130	125	170
	8.0	32.0	40.8	105	100	135
	10.0	39.2	49.9	85	80	110
	12.5	47.7	60.8	70	70	90
160 x 80	4.0	14.4	18.4	220	175	260
	5.0	17.8	22.7	180	145	215
	6.3	22.2	28.2	145	115	170
	8.0	27.6	35.2	115	95	140
	10.0	33.7	42.9	95	75	115
	12.5	40.9	52.1	80	65	95
200 x 100	5.0	22.6	28.7	175	140	210
	6.3	28.1	35.8	140	115	170
	8.0	35.1	44.8	110	90	135
	10.0	43.1	54.9	95	75	110
	12.5	52.7	67.1	75	60	90
	16.0	65.2	83.0	60	50	75
200 x 120	5.0	24.1	30.7	170	145	210
	6.3	30.1	38.3	140	115	170
	8.0	37.6	48.0	110	95	135
	10.0	46.3	58.9	90	75	110
	12.5	56.6	72.1	75	65	90
	14.2	63.3	80.7	65	55	80
	16.0	70.2	89.4	60	50	75

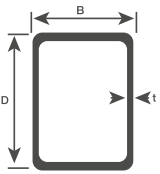
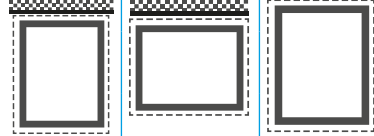
A/V Tables for Steelwork Encasements

Table 3t Rectangular Hollow Sections (RHS)				Section factor A/V (Hp/A)		
Dimensions to EN 10210 S355J2H				3 sides	3 sides	4 sides
Designation		Mass	Area of section A			
Size D x B	Wall thickness t			m ⁻¹	m ⁻¹	m ⁻¹
mm	mm	kg/m	cm ²			
200 x 150	5.0	26.5	33.7	165	150	210
	6.3	33.0	42.1	135	120	170
	8.0	41.4	52.8	105	95	135
	10.0	51.0	64.9	80	80	110
	12.5	62.5	79.6	70	65	90
	14.2	70.0	89.2	65	60	80
	16.0	77.7	99.0	55	55	70
250 x 100	5.0	26.5	33.7	180	135	210
	6.3	33.0	42.1	145	110	170
	8.0	41.4	52.8	115	85	135
	10.0	51.0	64.9	95	70	110
	12.5	62.5	79.6	75	60	90
	14.2	70.0	89.2	70	50	80
	16.0	77.7	99.0	65	45	70
250 x 150	5.0	30.4	38.7	170	145	210
	6.3	38.0	48.4	135	115	165
	8.0	47.7	60.8	110	90	135
	10.0	58.8	74.9	90	75	110
	12.5	72.3	92.1	75	60	90
	14.2	81.1	103	65	55	80
	16.0	90.3	115	60	50	70
250 x 200	10.0	66.7	84.9	85	80	110
	12.5	82.1	105	70	65	90
	14.2	92.3	118	60	55	80
260 x 140	5.0	30.4	38.7	170	140	210
	6.3	38.0	48.4	140	115	165
	8.0	47.7	60.8	110	90	135
	10.0	58.8	74.9	90	75	110
	12.5	72.3	92.1	75	60	90
	14.2	81.1	103	65	55	80
	16.0	90.3	115	60	50	70
300 x 100	5.0	30.4	38.7	180	130	210
	6.3	38.0	48.4	145	105	165
	8.0	47.7	60.8	115	85	135
	10.0	58.8	74.9	95	70	110
	12.5	72.3	92.1	80	55	90
	14.2	81.1	103	70	50	80
	16.0	90.3	115	65	45	70
300 x 150	8.0	54.0	68.8	110	90	130
	10.0	66.7	84.9	90	70	110
	12.5	82.1	105	75	60	90
	14.2	92.3	118	65	55	80
	16.0	103	131	60	50	70

A/V Tables for Steelwork Encasements

Table 3u Rectangular Hollow Sections (RHS)				Section factor A/V (Hp/A)		
				3 sides	3 sides	4 sides
Dimensions to EN 10210 S355J2H		Mass	Area of section A			
Size D x B	Wall thickness t			m ⁻¹	m ⁻¹	m ⁻¹
300 x 200	5.0	38.3	48.7	165	145	205
	6.3	47.9	61.0	135	115	165
	8.0	60.3	76.8	105	95	130
	10.0	74.5	94.9	85	75	105
	12.5	91.9	117	70	60	85
	14.2	103	132	60	55	75
	16.0	115	147	55	50	70
300 x 250	6.3	52.8	67.3	130	120	165
	8.0	66.5	84.8	100	95	130
	10.0	82.4	105	85	80	105
	12.5	102	130	65	65	85
	14.2	115	146	60	55	75
	16.0	128	163	55	50	70
350 x 150	6.3	47.9	61.0	140	110	165
	8.0	60.3	76.8	110	85	130
	10.0	74.5	94.9	90	70	105
	12.5	91.9	117	75	55	85
	14.2	103	132	65	50	75
	16.0	115	147	60	45	70
350 x 250	6.3	57.8	73.6	130	115	165
	8.0	72.8	92.8	105	95	130
	10.0	90.2	115	85	75	105
	12.5	112	142	70	60	85
	14.2	126	160	60	55	75
	16.0	141	179	55	50	70
400 x 120	6.3	49.9	63.5	145	100	165
	8.0	62.8	80.0	115	80	130
	10.0	77.7	98.9	95	65	105
	12.5	95.8	122	75	55	85
	14.2	108	137	70	50	80
	16.0	120	153	65	45	70
	400 x 150	6.3	52.8	67.3	145	105
8.0		66.5	84.8	115	85	130
10.0		82.4	105	90	70	105
12.5		102	130	75	55	85
14.2		115	146	65	50	75
16.0		128	163	60	45	70
400 x 200		6.3	57.8	73.6	140	110
	8.0	72.8	92.8	110	90	130
	10.0	90.2	115	90	70	105
	12.5	112	142	70	60	85
	14.2	126	160	65	50	75
	16.0	141	179	60	45	70

A/V Tables for Steelwork Encasements

Table 3v Rectangular Hollow Sections (RHS)				Section factor A/V (Hp/A)		
Dimensions to EN 10210 S355J2H				3 sides	3 sides	4 sides
Designation						
Size D x B	Wall thickness t	Mass	Area of section A			
mm	mm	kg/m	cm ²	m ⁻¹	m ⁻¹	m ⁻¹
400 x 300	8.0	85.4	109	105	95	130
	10.0	106	135	85	75	105
	12.5	131	167	70	60	85
	14.2	148	189	60	55	75
	16.0	166	211	55	50	70
450 x 250	8.0	85.4	109	105	90	130
	10.0	106	135	85	70	105
	12.5	131	167	70	60	85
	14.2	148	189	65	50	75
	16.0	166	211	55	45	70
500 x 200	8.0	85.4	109	110	85	130
	10.0	106	135	90	70	105
	12.5	131	167	75	55	85
	14.2	148	189	65	50	75
	16.0	166	211	60	45	70
500 x 300	8.0	97.9	125	105	90	130
	10.0	122	155	85	75	105
	12.5	151	192	70	60	85
	14.2	170	217	60	50	75
	16.0	191	243	55	45	70
	20.0	235	300	45	40	55

NOTE: Data on older and other steel sizes can be found on either the ASFP website/technical section (www.asfp.org.uk) or Corus website (www.corusgroup.com)

Table 3w Castellated Sections			Castellated Universal Beams (continued)			Castellated Universal Beams (continued)		
Castellated Universal Beams			Castellated Universal Beams (continued)			Castellated Universal Beams (continued)		
Serial size		Mass	Serial size		Mass	Serial size		Mass
Original	Castellated	kg/m	Original	Castellated	kg/m	Original	Castellated	kg/m
mm	mm		mm	mm		mm	mm	
914 x 419	1371 x 419	388 343	457 x 152	686 x 152	82 74 67 60 52	356 x 406	546 x 406	634 551 467 393 340 287 235
914 x 305	1371 x 305	289 253 224 201	406 x 178	609 x 178	74 67 60 54	356 x 368	534 x 368	202 177 153 129
838 x 292	1257 x 292	226 194 176	406 x 140	609 x 140	46 39	305 x 305	458 x 305	283 240 198 158 137 118 97
762 x 267	1143 x 267	197 173 147	356 x 171	534 x 171	67 57 51 45	254 x 254	381 x 254	167 132 107 89 73
686 x 254	1029 x 254	170 152 140 125	356 x 127	534 x 127	39 33	203 x 203	305 x 203	86 71 60 52 46
610 x 305	915 x 305	238 179 149	305 x 165	458 x 165	54 46 40	152 x 152	228 x 152	37 30 23
610 x 229	915 x 229	140 125 113 101	305 x 127	458 x 127	48 42 37 31			
533 x 210	800 x 210	122 109 101 92 82	305 x 102	458 x 102	33 28 25			
457 x 191	686 x 191	98 89 82 74 67	254 x 146	381 x 146	43 37 31			
			254 x 102	381 x 102	28 25 22			
			203 x 133	305 x 133	30 25			

CELLULAR BEAMS

To accommodate building service within the beam depth, steel beams are now available with a variety of web apertures, to form cellular and castellated beams. Whilst hexagonal, rectangular and elongated lozenge shaped apertures are available, circular apertures are the most common (refer to page 40/page 43).

A mixture of such aperture shapes is also possible. See Section 6 of AAFP Yellow Book. Further information can be found on page 41 of this Handbook.

Promat VERMICULUX® Encasements

ENCASEMENT: 3-SIDED TO COLUMNS AND BEAMS ABUTTING WALL OR STRUCTURAL SOFFIT

Board thickness

Board thickness is determined in accordance with the section factor and the limiting steel temperature. See tables 3x to 3ag.

Framing

19mm x 32mm x 0.65mm to 38mm x 50mm x 1.2mm steel should be fixed to the flange of the steel section or to the adjacent wall. Minimum angle size 32mm x 32mm, if shot firing.

Fixings

Angle to Flange

Shot fired 3.7mm x 16mm nails (Hot ENK 16 S12 or equivalent) or self-tapping 10mm x M4 panhead screws at 300mm centres.

Angle to Wall or Soffit

Shot fired 3.7mm x 16mm nails (Hot ENK 16 S12 or equivalent), self-tapping 32mm x M4 panhead screws into non-combustible plugs or Spit Hammer-In CL 35 or equivalent wall steel expansion anchors 6mm x 35mm at 300mm centres.

Board to Angle

M4 countersunk self-tapping hardened steel or dry wall screws at nominal 285mm centres. Five screws for 1220mm board length. Screw length should allow minimum of 10mm penetration through the angle.

Board to Board

For columns, M4 countersunk high quality deep thread screws at nominal 190mm centres, i.e. seven screws for 1220mm board length. For beams, M4 countersunk high quality deep thread screws at nominal 180mm centres, i.e. eight screws for 1220mm board length as flange (soffit) board joint is staggered from web board joint (see illustration). End screw fixing 20mm from the rebate edge. Use M5 high quality deep thread screws for screw lengths greater than 75mm. A minimum penetration of 30mm is required when edge screwing Promat VERMICULUX®.

Board Joints

Transverse column joints coincident between adjacent boards. Reverse beam joints staggered by a nominal 240mm between web and flange face boards.

Joint Backing

None required.

The fixing methods shown are suitable for use with beams up to 686mm in depth.

For deeper beam depths up to 2000mm, please refer to Certifire approval CF421 or consult Promat Technical Services Department.

Certifire Approval No CF 421

MAINTAINING

COMPARTMENTATION

If it is also required to provide fire insulation across the beam or column in order to maintain compartmentation to the criteria of BS 476: Part 22: 1987 (maintaining insulation to average temperature rise of 140°C, maximum temperature rise 180°C), then the minimum thickness of the Promat VERMICULUX® board on each side of the beam or column must be as follows:

Fire resistance (minutes)	Board thickness (mm)
60	20
90	25
120	30
150	35
180	40
240	50

PROMAT VERMICULUX®

(UP TO 240 MINUTES - A/V 17 -- 260M-1)

Promat VERMICULUX® is a lightweight non-combustible board specially designed to provide fire protection to structural steelwork. Up to 240 minutes fire resistance can be achieved depending on the thickness of material used, the dimensions of the beam or column being protected, and the limiting temperature of the steel section. Promat VERMICULUX® can be installed prior to the building being weathertight.

Fig 3.10.1

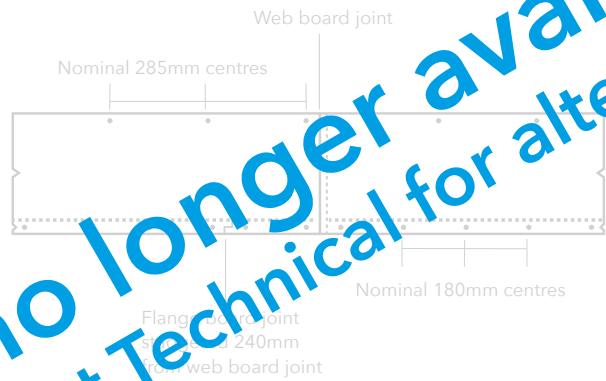


Fig 3.10.1 - Nominal centres in relation to board joints for beams - Side elevation

Fig 3.10.2



Promat VERMICULUX® beam casing showing staggered joints and using steel angles to soffit

Please note: Additional details are available for use in situations where a partition system is connected to the protected beam or column. Please contact the Promat Technical Services Department for further information.

Product no longer available
Consult Promat Technical for alternatives

Product no longer available
Consult Promat Technical for alternatives

ENCASEMENT: 4-SIDED TO FORM BOX CASING TO COLUMNS

Board Thickness: Board thickness required is determined in accordance with the required section factor and the limiting steel temperature. See tables 3x to 3ag.
Framing: None. Board screwed to board edge.

Fixings: Countersunk M4 countersunk high quality deep thread screws at nominal 190mm centres, i.e. seven screws for 1220mm board length. The end screw fixing should be 20mm from rebate edge; screw length to give minimum penetration of 30mm into the board edge. Use M5 countersunk high quality deep thread screws for screw lengths greater than 75mm.

Board Joints: Transverse joints can be coincident between adjacent sides.

Joint Backing: None required.

Fig 3.10.3 Promat VERMICULUX® Column casing using edge fixing



Fig 3.10.4 Promat VERMICULUX® beam casing using steel angles

ENCASEMENT: 4-SIDED TO FORM BOX CASING TO BEAMS

Board Thickness: Board thickness required is determined in accordance with the required section factor and the limiting steel temperature. See tables 3x to 3ag.

Framing: 19mm x 32mm x 0.65mm to 38mm x 50mm x 1.6mm steel angle fixed to the flange of the steel section. Minimum angle size 27mm x 32mm if shot firing.

Fixings: Angle to flange: Shot fired 3.7mm x 30mm nails (Hilti E-clip 312 or equivalent) or self-tapping 10mm x M4 countersunk screws at 300mm centres.

Board to angle: M4 countersunk high quality deep thread self-tapping or dry wall screws at nominal 285mm centres, i.e. five screws for 1220mm board length. Screw length should allow minimum of 10mm penetration through the angle.

Board to board: M4 countersunk high quality deep thread screws at nominal 180mm centres, i.e. eight screws for 1220mm board length as flange board joint is staggered from web board joint (see illustration). End screw fixing 20mm from the rebate edge. Use M5 countersunk high quality deep thread screws for screw lengths greater than 75mm. A minimum penetration of 30mm is required when edge screwing Promat Vermiculux®.

Board joints: Transverse joints staggered by a nominal 240mm between web and flange face boards.

Joint backing: None required.

Fig 3.10.4



Promat VERMICULUX® beam casing using steel angles

Certifire Approval No CF 421

ONE-SIDED CASINGS

Fig 3.10.5



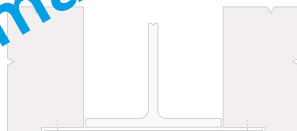
For columns: Light gauge steel angle sections fixed to steelwork with M4 screws or shot-fired fixings at 300mm centres. Boards fixed to angle sections with M4 self-tapping screws at 300mm centres; screw length to provide 10mm penetration through angle.

Fig 3.10.6



For columns: Boards fixed to blockwork with M4 screws at 300mm centres into metal plugs; screw length to provide 30mm penetration into plug. Fixings to be minimum 50mm from edge of blockwork.

Fig 3.10.7



For columns: Boards fixed to blockwork with M4 screws at 300mm centres into metal plugs; screw length to provide 30mm penetration into plug. Fixings to be minimum 50mm from edge of blockwork.

Fig 3.10.8



For columns or beams: Boards fixed to blockwork with M4 screws at 300mm centres into metal plugs; screw length to provide 30mm penetration into plug. Fixings to be minimum 50mm from edge of blockwork.

Fig 3.10.9



For columns: Boards fixed to the column flange with either screws or shot-fired nails. The screws are M4 steel self-tapping, and nails are 3.6mm or 4.0mm steel shot fire nails. All fixings are 265mm minimum centres, and must be of such length that they penetrate at least 10mm beyond the interface of the board and steel flange. The screws and nails may be fixed with or without steel washers. Two vertical rows of fixings are used, each row between 25mm and 85mm from the adjacent vertical edge of the board.

Two-sided casings

Fig 3.10.10



For columns or beams: Light gauge steel zed sections fixed to steelwork with M4 screws or shot-fired fixings at 300mm centres. Board fixed to zed section with M4 self-tapping screws at 300mm centres; screw length to provide 10mm penetration through section.

Fig 3.10.11



For columns: Light gauge steel angle sections fixed to blockwork with M4 screws at 300mm centres into metal plugs; screw length to provide 30mm penetration into plug. Board fixed to angle section with M4 self-tapping screws at 300mm centres; screw length to provide 10mm penetration through section.

Fig 3.10.12



For columns or beams: Light gauge steel angle sections fixed to steelwork with M4 screws or shot-fired fixings at 300mm centres. Board fixed to angle section with M4 self-tapping screws at 300mm centres; screw length to provide 10mm penetration through section.

Product no longer available
Consult Promat Technical for alternatives

EXTENDING STEELWORK CASING TO MEET WALLS AND ROOFS

The details below show methods of extending a Promat VERMICULUX® casing to meet walls and roofs. This is often required for aesthetic reasons, where access is limited or when compartmentation is required to be maintained.

For the upper detail, if it is required to extend the compartmentation to use external cladding then the minimum thicknesses of Promat VERMICULUX® shown in Table 3wa should be used in order to maintain the compartmentation and provide protection to the steel section. In both cases the maximum depth of the casing is 1m.

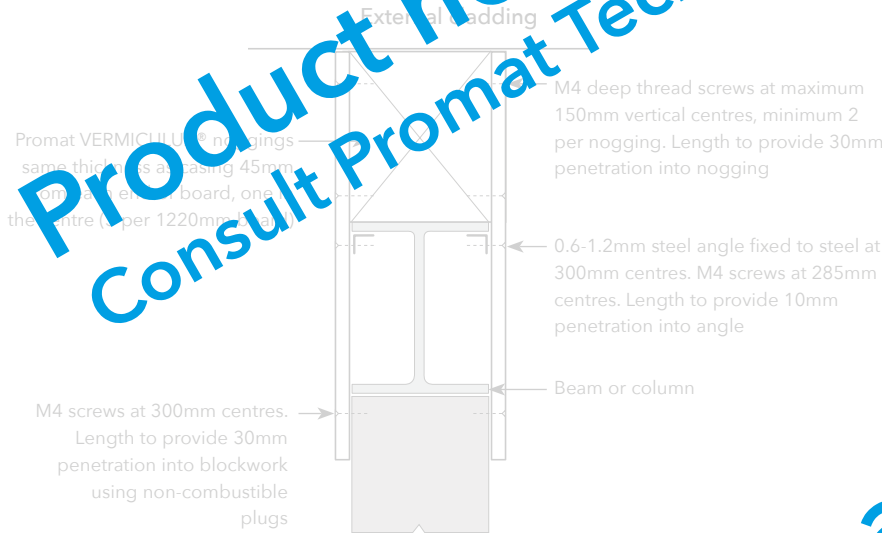


Fig 3.10.13

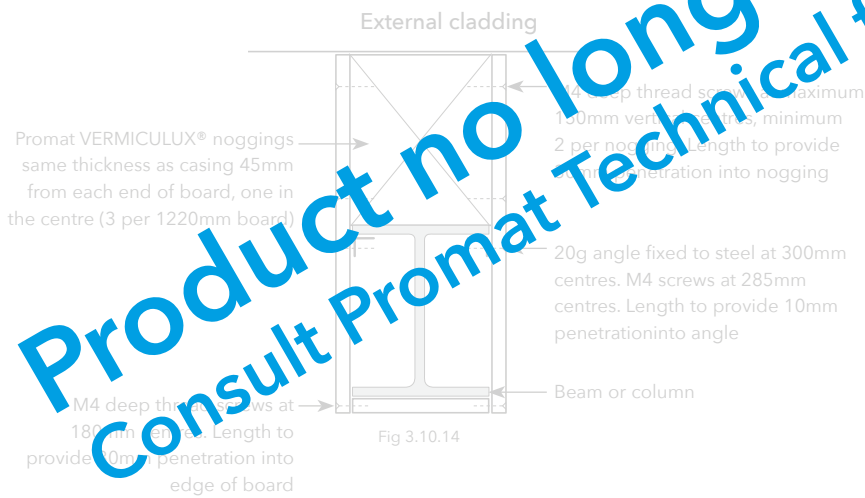


Fig 3.10.14

Table 3wa
EXTENDING STEELWORK CASING TO MEET WALLS AND ROOFS

Fire resistance (minutes)	Thickness (mm) of Promat VERMICULUX® board - each side required for compartmentation
60	20
90	25
120	30
150	35
180	40
240	50

Limiting temperatures for standard steel sections are shown in the following tables. Please consult a qualified structural engineer for detailed advice if steel sizes fall outside those shown.

Certifire Approval No CF 421

FIRE PROTECTION THICKNESS - PROMAT VERMICULUX® A/V RATIO
COLUMN AND BEAM CLADDINGS

Fire Resistance: Up to 240 minutes to BS 5837: Part 21: 1987
Determine A/V factor of steel section by referring to Table 3 to page 62. Read off from the chart the thickness of Promat VERMICULUX® needed according to the fire resistance period required and the limiting temperatures of the steel.

Table 3
Columns and beams - limiting steel temperature 550°C

Section factor A/V - m ⁻¹	Fire resistance period - minutes						Board thickness (mm)
	30	60	90	120	180	240	
260	260	202	114	61	-	20	
		260	159	81	54	25	
			215	103	67	30	
			260	128	82	35	
				156	98	40	
				189	115	45	
				227	134	50	
				260	155	55	
						60	

Table 3y.
Columns and beams - limiting steel temperature 620°C

Section factor A/V - m ⁻¹	Fire resistance period - minutes						Board thickness (mm)
	30	60	90	120	180	240	
260	260	260	174	94	79	20	
			260	134	105	25	
				260	136	30	
					171	35	
					213	40	
					260	45	
						50	
						55	
						60	

Product no longer available
Consult Promat Technical for alternatives

Product no longer available
Consult Promat Technical for alternatives

Table 3z.

Columns and beams - limiting steel temperature 300°C

Section factor A/V - m ⁻¹	Fire resistance period - minutes						Board thickness (mm)
	30	60	90	120	180	240	
260	119	61	41	24	-	20	
	183	84	54	32	-	25	
	260	112	70	42	28	30	
		148	88	48	33	35	
		194	109	58	38	40	
		255	134	68	46	45	
		327	163	80	52	50	
		411	199	92	60	55	
		507	244	106	67	60	

Table 3y.

Columns and beams - limiting steel temperature 350°C

Section factor A/V - m ⁻¹	Fire resistance period - minutes						Board thickness (mm)
	30	60	90	120	180	240	
260	160	77	51	30	-	20	
	252	107	68	39	27	25	
	260	145	88	49	34	30	
		193	111	60	41	35	
		258	138	72	48	40	
		260	171	85	56	45	
			211	99	64	50	
			260	115	73	55	
				132	83	60	

Table 3ab.

Columns and beams - limiting steel temperature 400°C

Section factor A/V - m ⁻¹	Fire resistance period - minutes						Board thickness (mm)
	30	60	90	120	180	240	
260	116	57	37	23	-	20	
	136	74	47	29	33	25	
		187	109	59	41	30	
		254	139	73	49	35	
		260	175	87	58	40	
			218	103	68	45	
			260	121	78	50	
				141	89	55	
				164	101	60	

Certifire Approval No CF 421

Product no longer available
 Consult Promat Technical for alternatives

Table 3ac.

Columns and beams - limiting steel temperature 450°C

Section factor $\Delta V - m^{-1}$	Fire resistance period - minutes						Board thickness (mm)
	30	60	90	120	180	240	
260	260	121	77	43	-	20	
		173	95	57	39	25	
		213	135	71	48	30	
		260	174	88	59	35	
			222	106	69	40	
			260	126	81	45	
				149	94	50	
				175	107	55	
				204	122	60	

Table 3ad.

Columns and beams - limiting steel temperature 500°C

Section factor $\Delta V - m^{-1}$	Fire resistance period - minutes						Board thickness (mm)
	30	60	90	120	180	240	
260	260	154	92	51	-	20	
		225	127	68	-	25	
		260	169	86	-	30	
			220	100	69	35	
			260	130	82	40	
				154	92	45	
				188	112	50	
				225	129	55	
				255	147	60	

Table 3ae.

Columns and beams - limiting steel temperature 600°C

Section factor $\Delta V - m^{-1}$	Fire resistance period - minutes						Board thickness (mm)
	30	60	90	120	180	240	
260	260	260	145	73	-	20	
			207	97	63	25	
			260	125	80	30	
				157	97	35	
				194	117	40	
				237	138	45	
				260	162	50	
					188	55	
					218	60	

Product no longer available
 Consult Promat Technical for alternatives

Table 3af.

Columns and beams - limiting steel temperature 650°C

Section factor A/V - m ⁻¹	Fire resistance period - minutes						Board thickness (mm)
	30	60	90	120	180	240	
260	260	260	260	205	89	-	20
				260	120		25
					156	89	30
					202	117	35
					257	142	40
					260	175	45
						201	50
						238	55
						260	60

Table 3ag.

Columns and beams - limiting steel temperature 700°C

Section factor A/V - m ⁻¹	Fire resistance period - minutes						Board thickness (mm)
	30	60	90	120	180	240	
260	260	260	260	260	112	-	20
					156	89	25
					211	114	30
					260	142	35
						175	40
						214	45
						259	50
						260	55
							60

Product no longer available
 Consult Promat Technical for alternatives

Promat PROMATECT®-250

Certification: UL-EU-01220-CPR

PROMAT PROMATECT®-250 (UP TO 120 MINUTES – A/V 17-350m⁻¹)

Promat PROMATECT®-250 is a non-combustible mineral bound light weight board. It has a smooth matt upper surface and is off-white in appearance.

Promat PROMATECT®-250 provides a high degree of strength, dimensional stability, and fire performance to structural steelwork. Up to 120 minutes fire resistance can be achieved depending on the thickness of material used and the dimensions of the beam or column being protected, and the limiting temperature of the steel section.

PROMAT PROMATECT® -250

Detail A - Soldiers

Beams and Columns up to 400mm deep

For ease of installation, divide the soldier in half with a sloping cut and tap the two parts together as shown in Detail A (below).

Beams and Columns over 400mm deep to 600mm

For deeper sections, each soldier requires to be strengthened using a Promat PROMATECT®-250 stiffener to form a T-shaped soldier and is wedged between the flanges. The standard soldier is then stapled to the outer edge of the stiffener to form the T-shaped soldier.

COLUMNS

The fixing methods shown are suitable for use with columns up to 600mm in depth. For deeper column depths, please consult Promat Technical Services Department.

1. Promat PROMATECT®-250 soldiers, 100mm x thickness of casing, wedged into the web at the head and base of the column. Cover strips are not required at other joints in the boards covering flanges. Additional soldiers are not required behind joints in the second layer of a double layer casing. Soldiers are optional for web joints in other areas.
2. Promat PROMATECT®-250. Select board thickness from the following A/V Tables for Beam and Column Encasements (see page 76). Stagger joints on adjacent sides by at least 530mm. Secure boards to each other at corners, and to soldiers, using chisel point staples, 50mm x 12.5mm x 1.6mm at maximum 150mm centres. Staples 35mm x 12.5mm x 1.6mm can be used for boards 15mm thick. Full length boards up to 2500mm long can be used. The end staples are located nominally 40mm from the corner.
3. Chisel point staples, 50mm x 12.5mm x 1.6mm at 150mm maximum centres. Locate end staples 40mm from corner of board. For single layer boards 15mm thick, the length of the staples may be reduced to 35mm.

Fig 3.20.1

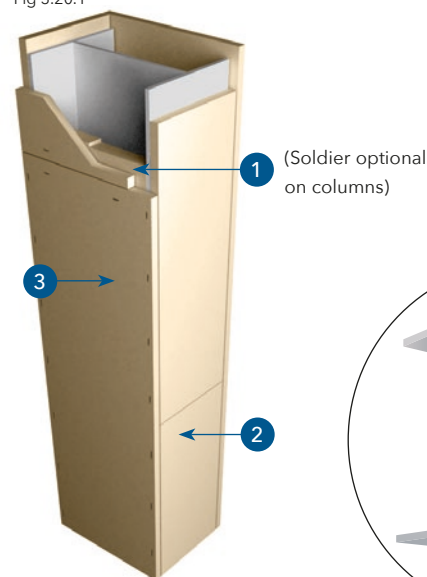


Fig 3.20.2

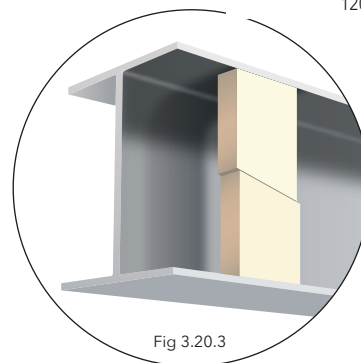
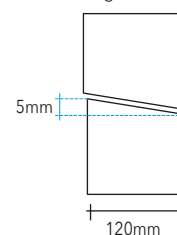


Fig 3.20.3

Detail A

Columns (Continued)

Detail B - 3 Sided Encasement

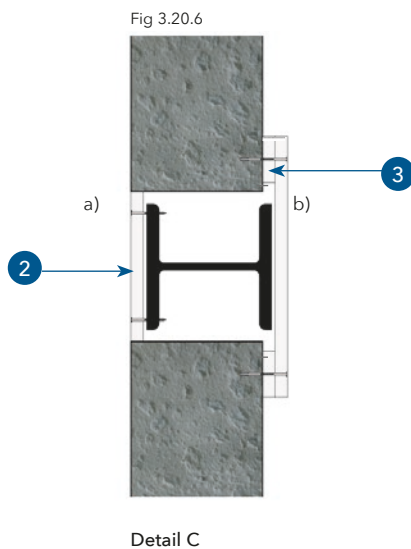
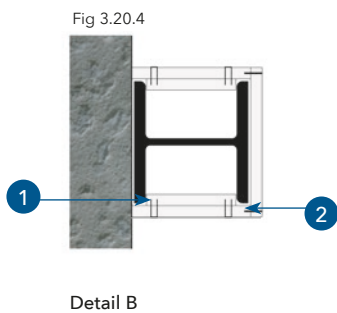
Either

secure boards (2) to each other and to soldiers (1) using steel staples as normal
or

as an alternative to using Promat PROMATECT®-250 soldiers, the side boards may be secured using continuous galvanised steel angles minimum, 50mm x 25mm x 0.5mm thick. The angles are fastened to the steel column with minimum M4 x10mm pan-head steel screws or 3.7mm x 16mm shot-fired nails at maximum 500mm centres. The boards are fastened to the angles with steel drywall screws at 200mm nominal centres.

Detail C - 1 Sided Encasement

- a) Promat PROMATECT®-250 (2), fixed directly to flange, using two rows of M4 CSK self drilling screws or 3.7mm shot-fired nails at maximum 300mm staggered centres.
- or
- b) Alternatively, overlap wall by at least 75mm and screw to wall with minimum M4 steel screws into metal plugs, non-combustible concrete anchors or concrete screws (by others) at 300mm centres. Packer strips (3) may be required.



Certification: UL-EU-01220-CPR

MAINTAINING COMPARTMENTATION

If it is also required to provide fire insulation across the beam or column in order to maintain compartmentation to the criteria of EN 1363-1: 2020 (maintaining insulation to average temperature rise of 140°C, maximum temperature rise 180°C), then the minimum thickness of the Promat PROMATECT®-250 board on each side of the beam or column must be as follows:

Fire resistance (minutes)	Board Thickness (mm)
60	15
90	20
120	25

BEAMS

Either

3 Sided Beam Encasement up to 400mm deep

1. Promat PROMATECT®-250 soldiers (1), 100mm wide positioned behind the side board joints and at 1250mm maximum centres. Single layer casing - soldier thickness to be the same as the casing.
Double layer casing - soldier thickness to be the same as the thickest layer.
No cover strips required at joints in the boards covering flanges. Stagger joints between layers by at least 530mm.
2. Promat PROMATECT®-250 (2). Select board thickness from the following A/V Tables for Beam and Column Encasements (see page 76).
Maximum board length 1250mm can be used.
Secure boards to each other at corners, and to soldiers, using chisel point staples (3).
3. Chisel point staples (3), 50mm x 12.5mm x 1.6mm (35mm x 12.5mm x 1.6mm for 15mm boards) at 150mm maximum centres. Locate end staples 40mm from corner of board.

Or

As an alternative to using PROMATECT®-250 soldiers, the boards may be secured using continuous galvanised steel angles 50mm x 25mm minimum 0.5mm thickness secured to the top flange using M4 x 10mm pan-head screws or 3.7mm x 16mm shot-fired nails at maximum 500 centres. This is suitable for Beam Encasements up to 600mm deep.

Fig 3.20.7

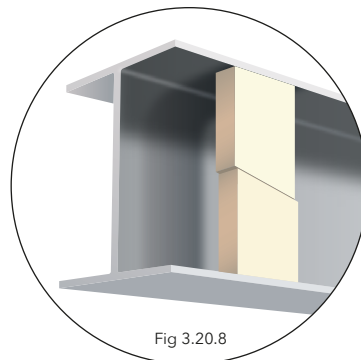
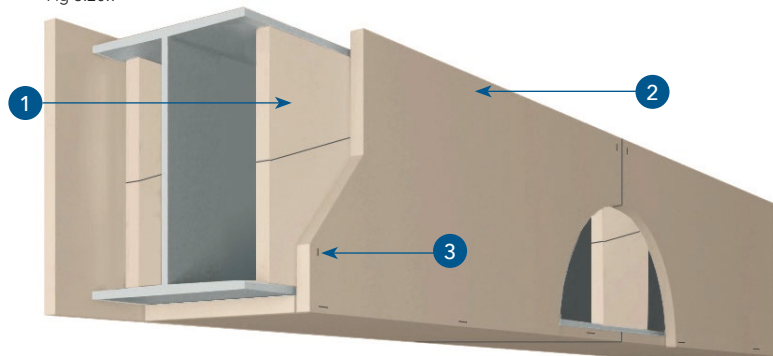


Fig 3.20.8

Detail D - 1 Sided Encasement

Either

a) Secure boards to two continuous galvanised angles, 50mm x 25mm x minimum 0.5mm thickness, or similar, using M4 CSK self tapping (or drywall) screws at 200mm centres. Angles (4) secured to top and bottom flanges at maximum 500mm centres. Back vertical joints with a Promat PROMATECT®-250 cover strip, (5) 100mm wide x 15mm thick. Infill above the beam with rock wool. Maximum board length 1250mm to coincide with the position of the cover strip.

Or

b) Secure boards as normal to Promat PROMATECT®-250 soldiers. Retain lower edge with a continuous galvanised zed section (10) fixed to wall at 500mm centres, leaving room for movement of beam. Secure top edge to galvanised channel (6) using screws at 200mm centres. Fix channel (6) to sides of purlins (8) using angle cleats. Infill above the beam with mineral wool.

Detail E - 2 Sided Encasement

Secure side boards using soldiers or angles similar to Detail D. Fix top hat or zed section (9) to beam at 500mm centres. Then screw the soffit board to the continuous top hat or zed section (9) at 200mm centres. Edge staple side boards to soffit board or secure together using angle, 50mm x 25mm x minimum 0.5mm thickness and screws at 200mm centres.

Fig 3.20.9

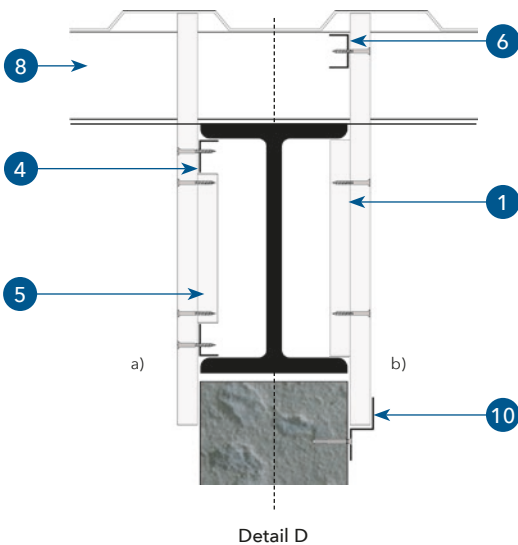
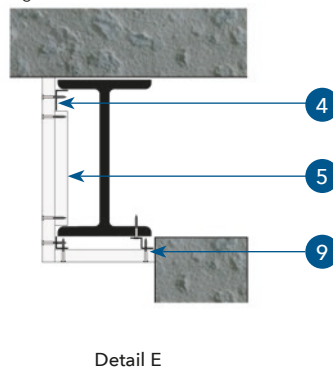


Fig 3.20.10



Please note: Additional details are available for use in situations where a partition system is connected to the protected steel column or beam. Please contact the Promat Technical Services Department for further information. It is essential that appropriate lateral restraint is provided between the wall/partition and the beam.

Certification: UL-EU-01220-CPR

350°C

	Fire resistance period (minutes)				Board thickness (mm)	
	30	60	90	120	Single layer	Double layer
A/V Ratio	250	65	-	-	15mm	-
	350	115	60	-	20mm	-
		190	85	55	25mm	-
		350	120	70	-	15mm + 15mm
			205	95	-	15mm + 20mm
			350	140	-	20mm + 20mm
				240	-	20mm + 25mm
				350	-	25mm + 25mm

400°C

	Fire resistance period (minutes)				Board thickness (mm)	
	30	60	90	120	Single layer	Double layer
A/V Ratio	350	80	-	-	15mm	-
		140	70	-	20mm	-
		245	105	70	25mm	-
		350	170	90	-	15mm + 15mm
			305	120	-	15mm + 20mm
			350	180	-	20mm + 20mm
				325	-	20mm + 25mm
				350	-	25mm + 25mm

450°C

	Fire resistance period (minutes)				Board thickness (mm)	
	30	60	90	120	Single layer	Double layer
A/V Ratio	350	95	50	-	15mm	-
		175	85	55	20mm	-
		305	125	80	25mm	-
		350	205	100	-	15mm + 15mm
			350	135	-	15mm + 20mm
				190	-	20mm + 20mm
				310	-	20mm + 25mm
				350	-	25mm + 25mm

500°C

A/V Ratio	Fire resistance period (minutes)				Board thickness (mm)	
	30	60	90	120	Single layer	Double layer
350	115	55	-	-	15mm	-
	220	100	65	-	20mm	-
	350	155	95	-	25mm	-
		265	115	-	-	15mm + 15mm
		350	150	-	-	15mm + 20mm
			200	-	-	20mm + 20mm
			315	-	-	20mm + 25mm
			350	-	-	25mm + 25mm

550°C

A/V Ratio	Fire resistance period (minutes)				Board thickness (mm)	
	30	60	90	120	Single layer	Double layer
350	135	65	-	-	15mm	-
	280	120	75	-	20mm	-
	350	185	110	-	25mm	-
		350	140	-	-	15mm + 15mm
			175	-	-	15mm + 20mm
			235	-	-	20mm + 20mm
			350	-	-	20mm + 25mm
				-	-	25mm + 25mm

600°C

A/V Ratio	Fire resistance period (minutes)				Board thickness (mm)	
	30	60	90	120	Single layer	Double layer
350	165	75	50	-	15mm	-
	350	140	85	-	20mm	-
		220	125	-	25mm	-
		350	170	-	-	15mm + 15mm
			215	-	-	15mm + 20mm
			290	-	-	20mm + 20mm
			350	-	-	20mm + 25mm
				-	-	25mm + 25mm

Certification: UL-EU-01220-CPR

650°C

	Fire resistance period (minutes)				Board thickness (mm)	
	30	60	90	120	Single layer	Double layer
A/V Ratio	350	255	85	55	15mm	-
		350	160	95	20mm	-
			260	145	25mm	-
			350	230	-	15mm + 15mm
				290	-	15mm + 20mm
				350	-	20mm + 20mm
					-	20mm + 25mm
					-	25mm + 25mm

700°C

	Fire resistance period (minutes)				Board thickness (mm)	
	30	60	90	120	Single layer	Double layer
A/V Ratio	350	255	100	60	15mm	-
		350	190	110	20mm	-
			310	165	25mm	-
			350	340	-	15mm + 15mm
				350	-	15mm + 20mm
					-	20mm + 20mm
					-	20mm + 25mm
					-	25mm + 25mm

750°C

	Fire resistance period (minutes)				Board thickness (mm)	
	30	60	90	120	Single layer	Double layer
A/V Ratio	350	325	115	70	15mm	-
		350	220	125	20mm	-
			350	190	25mm	-
				350	-	15mm + 15mm
					-	15mm + 20mm
					-	20mm + 20mm
					-	20mm + 25mm
					-	25mm + 25mm

Promat SUPALUX® 3-Sided Columns and Beams

PROMAT SUPALUX®

Promat SUPALUX® is a non-combustible calcium silicate board reinforced with selected fibres and fillers.

Promat SUPALUX® is resistant to the effects of moisture and will not physically deteriorate when used in damp or humid conditions. Performance characteristics are not degraded by age or moisture.

Assessment Report
CC88231 PUKLRE

**MAINTAINING
COMPARTMENTATION**

Please note that the thicknesses of Promat SUPALUX® recommended are sufficient to provide fire protection to the structural steelwork in accordance with BS 476: Part 21: 1987, as detailed in tables 3ba and 3bb. Recommended thicknesses will not necessarily provide fire compartmentation across the beam or column in order to maintain compartmentation to the criteria of BS 476: Part 22: 1987 (maintaining insulation to average temperature rise of 140°C, maximum temperature rise 180°C). For further information please contact Promat Technical Services Department.

Please note: Additional details are available for use in situations where a partition system is connected to the protected steel column or beam. Please contact the Promat Technical Services Department for further information.

Table 3az

ENCASEMENT: 3-SIDED TO COLUMN OR BEAMS AND TO WALL OR STRUCTURAL SOFFIT

Board thickness:	See Table 3ba and 3bb.
Framing:	25mm x 25mm x 0.65mm to 1.2mm thick steel angle used to fix adjacent Promat SUPALUX® panels at the column or beam corners. 19mm x 32mm x 0.65mm to 1.38mm x 50mm x 1.2mm steel angle used to fix the casing to the flange of the steel section or to the adjacent wall or soffit. Minimum angle size 32mm x 32mm, if shot firing.
Fixings:	Angle to flange: Shot fired 3.7mm x 16mm nails (Hilti ENK 16 S12 or equivalent) or self-tapping 10mm x M4 panhead screws at 400mm centres. Angle to wall or soffit: Shot fired 3.7mm x 32mm nails (Hilti ENK 32 S12 or equivalent), self-tapping 32mm x M4 panhead screws into non-combustible plugs or Spit Hammer-In CL 35 all steel expanding anchors 6mm x 35mm at 400mm centres. Board to supporting angle: M4 countersunk self-tapping screws or dry wall screws at nominal 270mm centres, i.e. ten screws for 2440mm board length. Screw length should allow minimum 10mm penetration through angle. Casing corners: M4 countersunk self-tapping or drywall screws at nominal 240mm centres, i.e. eleven screws for 2440mm board length. Screw length should allow minimum 10mm penetration through corner angle.
Board joints:	Transverse joints coincident between adjacent sides.
Joint backing:	All transverse joints to be backed by 75mm wide Promat SUPALUX® cover strips in same thickness as casing and fixed on both sides of the joint using M4 self-tapping or drywall screws at maximum 160mm centres. Screw length should penetrate both layers of board.

ENCASEMENT: 4-SIDED TO FORM CASING TO COLUMNS

Board thickness:	See Table 3ba and 3bb.
Framing:	25mm x 25mm x 0.65mm to 1.2mm thick steel angle used to fix adjacent Promat SUPALUX® boards at the column corners.
Fixings:	Casing corners: Countersunk self-tapping or drywall M4 screws at 400mm centres i.e. eleven screws for 2440mm board length. Screw length to allow 10mm minimum penetration through corner angles.
Board joints:	Transverse joints coincident between adjacent sides.
Joint backing:	All transverse joints to be backed by 75mm wide Promat SUPALUX® cover strips in same thickness as casing and fixed on both sides of the joint using M4 self-tapping or drywall screws at maximum 160mm centres. Screw length should penetrate both layers of board.

ENCASEMENT: 4-SIDED TO FORM BOX CASING TO BEAMS

For information contact Promat Technical Services Department.

The fixing methods shown on the page opposite are suitable for use with steel sections up to 686mm in depth. For deeper beam depths consult the Promat Technical Services Department.

**Product no longer available
Consult Promat Technical for alternatives**

Table 3ba.

Limiting steel temperature 550°C

Section factor A/V – m ⁻¹	Fire resistance period - minutes				Board thickness (mm)
	30	60	90	120	
260	64	-	-	-	15
-	107	52	-	-	15
-	158	73	47	-	15
-	224	-	-	61	15

Table 3bb.

Limiting steel temperature 620°C

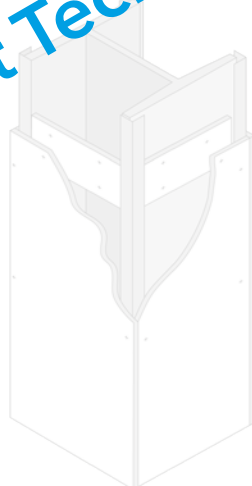
Section factor A/V – m ⁻¹	Fire resistance period - minutes				Board thickness (mm)
	30	60	90	120	
260	-	-	-	-	6
-	149	64	-	-	9
-	243	93	57	-	12
-	260	128	76	-	15

These tables reflect the most common limiting temperatures. For information on additional limiting temperatures between 300°C - 700°C, please contact Promat Technical Services Department.

Fig 3.30.1



Fig 3.30.2



Chapter 3: Structural Steel
Promat TD Board®

Certifire Approval No CF 529

PROMAT TD BOARD®

A lightweight, and easily worked fire protection board which offers up to 240 minutes fire protection depending on method of fixing, thickness of material used, dimensions of the steel beam and limiting temperatures of the steel section.

INSTALLATION METHOD

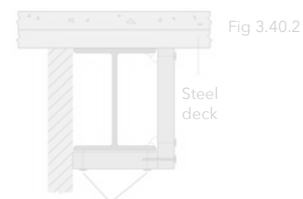
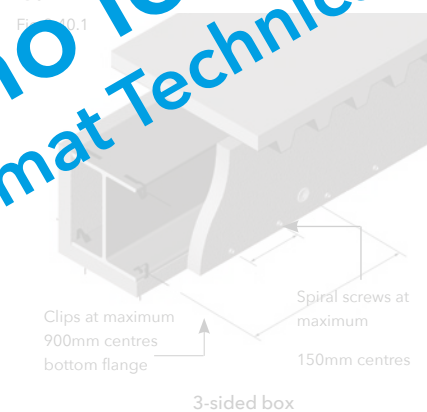
1. Friction fit the board lengthwise onto the top and bottom flanges at maximum 100mm centres for the top flange (A) and maximum 900mm centres for the bottom flange (D). The first clip is positioned at maximum 100mm in from the beam edge (B). The clip should be fitted by putting it onto the steel flange until an audible 'click' is heard.
2. Cut the Promat TD Board® boards to suit the depth of the beam whilst allowing for the additional flange cover board thickness.
3. Using the deck soffit as a guide, impale the Promat TD Board® boards onto the clip legs, always starting at the top.
4. Fit Promat TD Board® non-return washers onto the Promat TD Board® clip legs and push washers tight to the soffit face. (NB - for thick soffit's up to 30mm use 6mm washers and for thick soffit's up to 40mm use 8mm washers.)
5. Apply spiral screws horizontally at 150mm maximum centres, starting maximum 75mm from the board's vertical edge (C). Minimum screw length must be $2 \times$ cover board thickness less 5mm.
6. Tape joints with foil tape or scrim tape if required.

PROMAT TD BOARD® CLIP FIX DRY JOINT BOARD SYSTEM

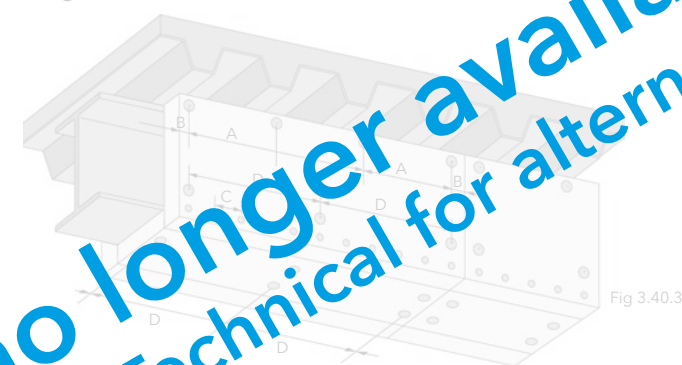
The unique Promat TD Board® clip fixing system is designed for ultimate speed of application. Its design features allow it to be used with standard steel deck types. The Promat TD Board® clip fixing solution can be used to provide 2, 3 and 4-sided beam protection for up to 120 minutes.

(120 minute A/V limitation for 100-1)

Typical Details



Fixing Pattern



3-sided box with Promat TD Board® clip fixing

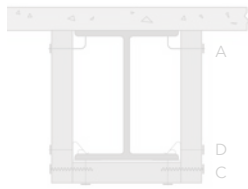
Dimensions:

- A Top flange clips at maximum 600mm centres for 2000mm boards and 500mm centres if 1200mm board length is used.
- B Clips at maximum 100mm, minimum 20mm from edge of board.
- C Spiral screws at maximum 150mm centres and maximum 75mm from board edge.
- D Bottom flange clips at maximum 900mm centres.

Combined Clip and Stud Welded Pin Dry Joint Systems

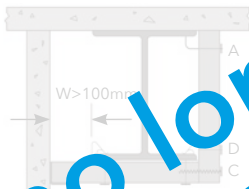
With concrete decks it may be necessary to fix stud welded pins to the top flange in place of clips.

Fig 3.40.4



3-sided box

Fig 3.40.5



2-sided box

Dimensions:

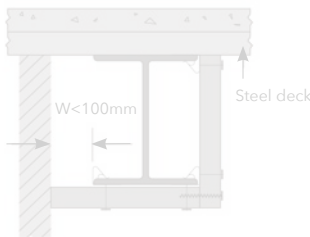
- A Pins at maximum 60mm centres
- B Pins at maximum 100mm centres. Where $W > 100\text{mm}$, a shelf angle or similar should be fixed to the wall
- C Spiral screw at maximum 150mm centres
- D Clip at maximum 900mm centres

Fig 3.40.6



3-sided box

Fig 3.40.7



2-sided box

Where $W < 100\text{mm}$, no shelf angle is required

Technical Approval No. 529

CONTINUING COMPARTMENTATION

If it is also required to provide fire insulation across the beam or column in order to maintain compartmentation to the criteria of BS 476: Part 22: 1987 (maintaining insulation to average temperature rise of 140°C, maximum temperature rise 180°C), then the minimum thickness of the Promat TD Board® board on each side of the beam or column must be as follows:

Fire resistance (mins)	Board thickness (mm)
60	25
90	30
120	35
150	40
180	45

Certifire Approval No CF 529

INSTALLATION METHOD

1. Clean the local area for pin welding and fix stud pin using arc or CD welds, ensuring a good contact has been achieved. Test weld by bending pin.
2. Impale the Promat TD Board® boards onto the stud welded pins using the deck soffit as a guide.
3. Push 38mm diameter spring steel non-return clips onto the exposed studs, tight to the board face. Crop clips as necessary.
4. Fix spiral screws to all board-to-board joints at 150mm maximum centres (C). Tape joints using aluminium foil tape or scrim, if required.

PROMAT TD BOARD® STUD WELDED PIN DRY JOINT BOARD SYSTEM

A stud welded pin solution with dry joints. This pin solution can be used for 2, 3 and 4-sided beam protection for a period of up to 120 minutes.

Typical Details

Fig 3.40.8

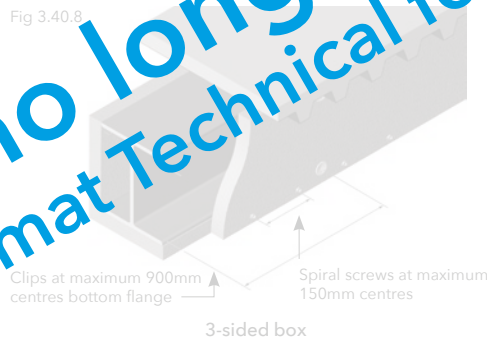
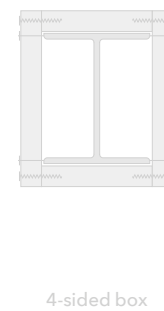


Fig 3.40.9



Fixing Pattern

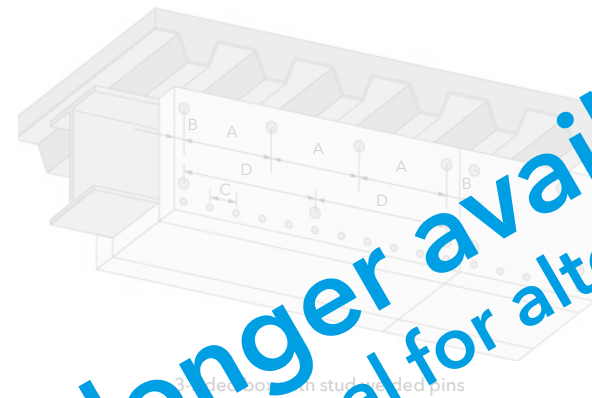


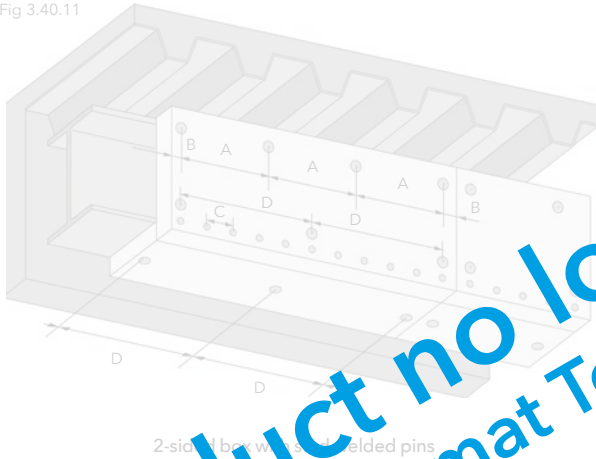
Fig 3.40.1

Dimensions

- A Stud welded pins at maximum 600mm centres for 2000mm board (500mm centres for 1200mm boards).
- B Stud welded pins at maximum 100mm centres, 20mm minimum from edge of board.
- C Spiral screws at maximum 150mm centres and maximum 75mm from edge of board.
- D Bottom flange stud welded pins at maximum 900mm centres.

Product no longer available
Consult Promat Technical for alternatives

Fig 3.40.11



2-sided box with welded pins

Dimensions:

- A Steel welded pins at maximum 150mm centres for 2000mm board (500mm centres for 1000mm boards).
- B Stud welded pins at maximum 100mm centres, 20mm minimum from edge of board.
- C Spiral screws at maximum 150mm centres.
- D Stud welded pins at maximum 900mm centres for bottom flange.

Fig 3.40.12

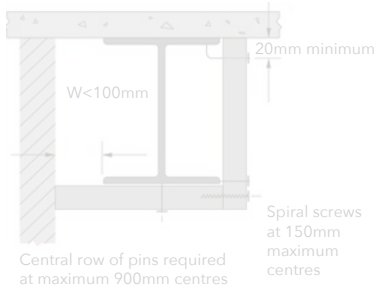
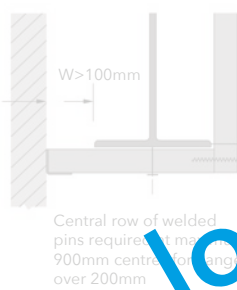


Fig 3.40.13



2-sided box

W limit is 100mm. Where W > 100mm, shelving or similar, to be fixed to the wall.

Certifire Approval No CF 529

INSTALLATION METHOD

1. Cut 120mm wide noggings (C) to suit web depth, using same thickness material as the cover protection. For web depths of 500mm and above use either solid noggings or T-noggings made from cover board thickness. These are then adhered using Promat VICUBOND® WB adhesive into position at 1000mm centres (D).
2. Cut the Promat TD Board® boards to suit the depth of the beam whilst allowing for an additional flange cover board thickness.
3. Push board tight to deck soffit and fix spiral screws through the coverboards and into the noggings at maximum 100mm centres (B).
4. Fix all board-to-board joints using spiral screws at 200mm maximum centres (A). Minimum screw length must be 2 x cover board thickness less 5mm.

ADHESIVE-FIX NOGGING DRY JOINT BOARD SYSTEM

A nogging solution which removes the necessity for adhesive-fix for board-to-board and board-to-nogging joints.

The board-to-board edge joints are fixed with spiral screws at 200mm centres. The adhered noggings are at 1000mm fixing centres. This fixing solution can be used for 2, 3 and 4-sided beam protection for up to 120 minutes.

Typical Details

Fig 3.40.14

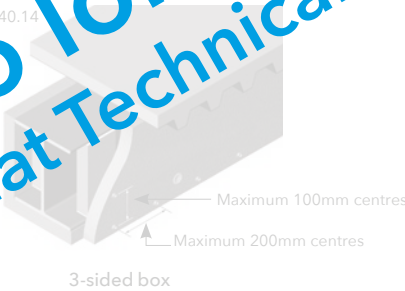
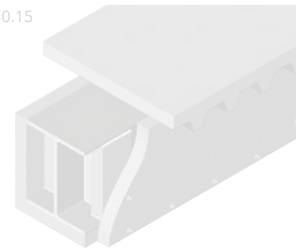


Fig 3.40.15



Fixing Pattern

Fig 3.40.16



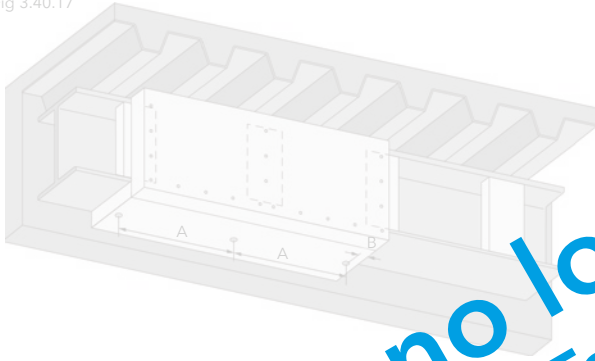
Dimensions

- A Spiral screws at maximum 200mm centres and maximum 50mm from edge of board.
- B Spiral screws at maximum 100mm centres into noggings.
- C Noggings of minimum 120mm width.
- D Noggings at maximum 1000mm centres.
- E Board length 2000mm.

Nogging thickness shall be minimum or equal to facing board thickness. If it is greater than 25mm. Use Promat TD Board® offcuts.

Product no longer available
 Consult Promat Technical for alternatives

Fig 3.40.17



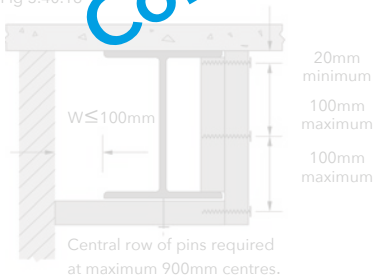
2-sided box using a combination of girders and stud welded pins

Dimensions:

A Welded pins at maximum 90mm centres for 100mm board (500mm centres for 1200mm boards)

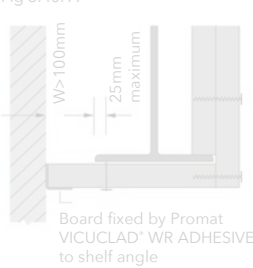
B Welded pins maximum 100mm (minimum 20mm) from board edge.

Fig 3.40.18



2-sided box

Fig 3.40.19



2-sided box

W limit is 100mm. Where W > 100mm a shelf angle or similar should be fixed to the wall.

Certifire Approval No CF 529

FIXING BOARDS TO NOGGINGS

Wherever three or four-sided protection is required, fixing to noggings is a practical option. No power supply is required.

FIXING BOARDS WITH STUD WELDED PINS

Situations will always occur where noggings do not allow a practical choice, e.g. for two-sided constructions. In these circumstances, perimeter boards can be secured with pinned brackets. Stud welded pins allow the installer a simple and alternative to nogging.

ADHESIVE-FIX NOGGING OR STUD WELDED PIN ADHESIVE BOARD JOINT SYSTEMS

The application of Promat VICUBOND® WR ADHESIVE enhances the fire performance over the dry joint systems for the 120, 180 and 240 minutes. The adhesive joint systems are capable of providing up to 240 minutes fire protection.

Installation Method (Nogging Fix)

1. Cut 20mm wide noggings to full web depth, using same thickness material as the cover protection. For web depths of 500mm and above use either solid noggings or T-nogging. For stability purposes, it is recommended that the face of the T-nogging is made from the same thickness as the cover board but the thickness of the return into the web should be at least 50mm. These are then adhered into position at 1000mm centres.
2. Apply Promat VICUBOND® WR ADHESIVE liberally to face of noggings. Quickly apply vertical boards and secure with nails long enough to pierce full thickness of noggings before Promat VICUBOND® WR ADHESIVE forms a hardened surface.
3. Apply Promat VICUBOND® WR ADHESIVE continuously and liberally to all board interfaces. Tightly butt to adjoining boards and nail through edge joints with same length nails as for noggings, at 400mm maximum centres.

Installation Method (Stud Welded Pin Fix)

1. Fit stud welded pins (3mm diameter) as indicated overleaf.
2. A selection of pins should be mechanically tested by bending the vertical and returning it to the original position.
3. Sprung steel non-return washers to secure boards.
4. Apply Promat VICUBOND® WR ADHESIVE to all board-to-board joints.
5. Offer up flange boards and nail throughs. Where corner joints at 400mm maximum centres.
6. If using faced boards, apply foil or scrim tape over joints for uniformity of appearance.

For additional fixing details not covered please contact Promat Technical Services Department.

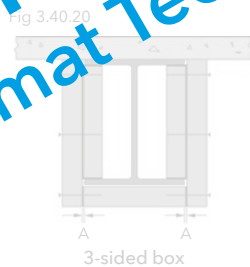


Fig 3.40.20
3-sided box
A Noggings to project slightly beyond flange.

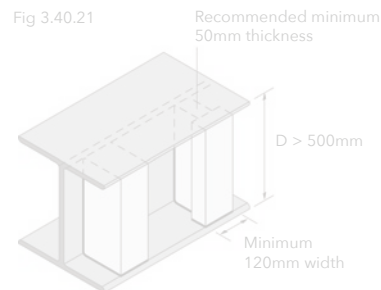
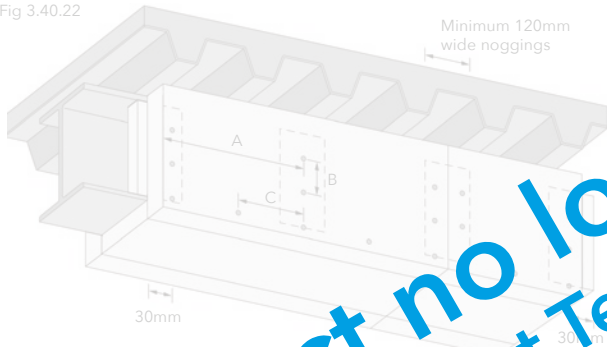


Fig 3.40.21
Full depth nogging or T-nogging
For web depths greater than 500mm, contact Promat Technical Services Department.

Product no longer available
Consult Promat Technical for alternatives

Fixing Pattern

Fig 3.40.22



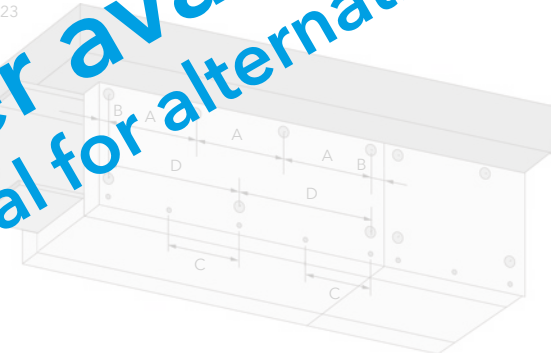
Fixing method using adhesive noggings, nails and adhesive board to joist/joints

Dimensions:

- A Stud pins at maximum 100mm centres.
- B Nails at maximum 150mm centres.
- C Nails at maximum 400mm centres (maximum 30mm from edge of board).

Stud Welded Pin Fixing Arrangement

Fig 3.40.23

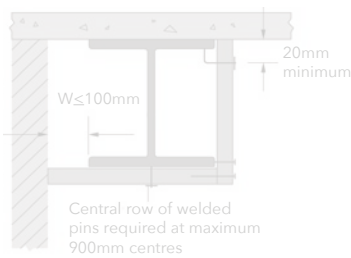


3-sided box with stud welded pins

Dimensions:

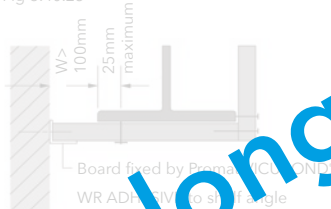
- A Stud welded pins at 600mm for 2000mm board (500mm for 1200mm boards).
- B Stud welded pins at maximum 100mm (minimum 20mm) from edge of board.
- C Nails at maximum 400mm centres.
- D Stud welded pins at maximum 900mm centres for 2000mm boards, 500mm centres for 1200mm boards - bottom flange.

Fig 3.40.24



2-sided box

Fig 3.40.25



Width limited to 100mm. For W > 100mm, a steel angle or similar should be fixed to the wall.

2-sided box

ADHESIVE-FIX SYSTEMS

Selecting the thickness of Promat TD Board® board for adhesive systems

Multi-layer applications

When a protection thickness in excess of 20mm is required, this can be achieved by applying two or more layers of Promat TD Board®. In practice, stagger the joints between each layer.

For welded pin application, each layer should be retained using separate non-return washer, i.e. one washer per layer.

For adhesive fixing, noggings and gasons, attach the first layer to the noggings as previously detailed, then apply a 120mm wide band of adhesive to the outside face of the first layer at locations corresponding to the noggings. Apply the outer layer of Promat TD Board®, supporting the boards until the adhesive sets by using nails of sufficient length to penetrate completely through the noggings.

BOARD JOINTING

Butted Corner Joints

Butted corner joints are made with square edge boards using either a dry joint with spiral screws (Fig 3.40.26), or Promat VICUBOND® WR ADHESIVE and nails at 400mm centres.

Axial Joints

All axial joints are made with square butt edges, without nails. Promat VICUBOND® WR ADHESIVE is only required for glued board systems (Fig 3.40.27).

For foil faced products, joints can be finished with Class '0' foil tape.

Noggings

Promat TD Board® can be fixed to noggings cut from Promat TD Board® or steel of at least the same thickness as the fascia and profile boards. The edges of the noggings are glued where they contact the steelwork, then, once the adhesive has set firmly, the cover boards are fixed in position with either spiral screws or Promat VICUBOND® WR ADHESIVE and nails.

Welded Steel Pins

Boards are impacted on a steel welded pin and secured with non-return washers.

Joints and Adhesive

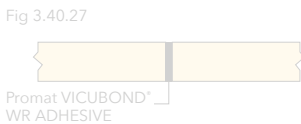
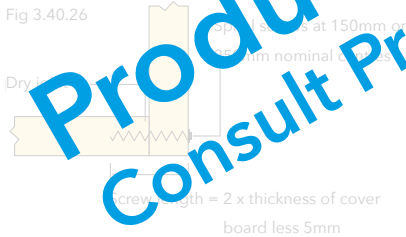
Promat VICUBOND® WR ADHESIVE is required between all board-to-board and board-to-nogging joints in adhesive systems, but only between nogging-to-steel joints for dry systems.

Applying Promat VICUBOND® WR ADHESIVE on the external face of joints is bad practice.

Whatever nogging system is employed, the adhesive between nogging and steel must be allowed to set hard before cover boards are applied to the noggings. This will normally take about 4 hours at 20°C ambient temperature.

Promat VICUBOND® WR ADHESIVE is supplied pre-mixed in 10 litre tubs.

Coverage rate will depend on the linear length of the joints, width of joint (board thickness) and joint depth. Assuming total, effective useage of the adhesive on site, the following table provides an approximate weight (kg) of adhesive per linear metre of joint, based on an adhesive depth of 1mm.



Product no longer available
Consult Promat Technical for alternatives

Table 3bc

Promat TD Board® Thickness (mm)	Square Butt Joint (Kg/LM joint per 1mm depth)
25	0.09
30	0.11
35	0.13
40	0.15
50	0.19
60	0.24

In practice, a degree of wastage should be expected and, as such, make an allowance for this when placing an order.

Promat VICUBONDS™ ADHESIVE is an inorganic, non-toxic product with a pH of 7-9.

A safety information sheet is available from the Promat Technical Services Department and, as with all other materials, should be read before working with the board. For additional details of product properties and application please contact Promat Technical Services Department.

Product no longer available
Consult Promat Technical for alternatives

Certifire Approval No CF 529

FIRE PROTECTION THICKNESS - PROMAT TD BOARD® RATIO FOR BEAM CLADDINGS

1. These fixing methods are suitable for steel sections up to 1000mm deep x 419mm wide. Clip fix method may only be used up to 40mm thickness. Above this use welded pin fix only. For larger sections a system protecting more than one section in a single endowment, please contact Promat Technical Services Department.
2. Where a column is exposed to a beam protected with a profiled fire protective system e.g. spray, the column webs should be sealed using Promat TD Board®.
3. For beams with depth more than 500mm, T-shaped or solid soldiers should be used. T-shaped soldiers are formed from two pieces of Promat TD Board® (minimum 100mm) joined using Promat Spring Screws. Solid soldiers are 120mm wide x full depth of the flange. If more than one thickness is used, use thicknesses together using Spring Screws.

For information on the thicknesses of Promat TD Board® please contact the Promat Technical Services Department.

Table 3bd. Clip fixings or welded pin fixings and 'dry joints' when protecting beams supporting concrete decks.

Limiting steel temperature 550°C

Section factor $AV - m^{-1}$	Fire resistance period - minutes						Thickness (mm)
	30	60	90	120	180	240	
260	260	201	-	-	-	25	
220	-	100	-	-	-	30	
180	-	-	126	-	-	35	
140	-	-	58	-	-	40	
100	-	-	195	-	-	45	
60	-	-	240	-	-	50	
20	-	-	260	-	-	55	
10	-	-	260	-	-	60	

Please note: Additional details are available for use in situations where a partition system is connected to the protected steel column or beam. Please contact the Promat UK Technical Services Department for further information.

**Product no longer available
Consult Promat Technical for alternatives**

Table 3be. Clip fixings or welded pin fixings and 'dry joints' when protecting beams (in other configurations than Table 3bd).

Limiting steel temperature 550°C

Section factor A/V - m ⁻¹	Fire resistance period - minutes						Board thickness (mm)
	30	60	90	120	180	240	
260	260		148	65	-	-	25
			206	84	-	-	30
			260	104	-	-	35
				128	-	-	40
				155	-	-	45
				184	-	-	50
				225	-	-	55
				260	-	-	60

Table 3bf. Clip fixings or welded pin fixings and 'dry joints' when protecting beams (loading in accordance with BS 5950-8).

Limiting steel temperature 620°C

Section factor A/V - m ⁻¹	Fire resistance period - minutes						Board thickness (mm)
	30	60	90	120	180	240	
260	260	260	260	95	-	-	25
				124	-	-	30
				159	-	-	35
				200	-	-	40
				251	-	-	45
				260	-	-	50
				260	-	-	55
				260	-	-	60

Table 3bg. Adhesive fixings and 'dry joints' when protecting beams.

Limiting steel temperature 550°C

Section factor A/V - m ⁻¹	Fire resistance period - minutes						Board thickness (mm)
	30	60	90	120	180	240	
260	260		146	65	-	-	25
			202	83	-	-	30
			260	103	-	-	35
				126	-	-	40
				153	-	-	45
				184	-	-	50
				221	-	-	55
				260	-	-	60

Certifire Approval No CF 529

Table 3bh. Adhesive fix noggings and 'dry joints' when protecting beams (Testing in accordance with BS 5950-8).

Limiting steel temperature 620°C

Section factor AAV - m ⁻¹	Fire resistance period - minutes					Board thickness (mm)
	30	60	90	120	240	
260	260	196	-	-	-	25
		260	93	-	-	30
			116	-	-	35
			143	-	-	40
			173	-	-	45
			209	-	-	50
			252	-	-	55
			260	-	-	60

Additional data to alternative limiting steel temperatures is also available. Contact Promat Technical Services for further information.

Table 3bi. Adhesive fix noggings or welded pin fixings and adhesive board joints when protecting beams.

Beams - Critical steel temperature 550°C

Section factor AAV - m ⁻¹	Fire resistance period - minutes					Board thickness (mm)
	30	60	90	120	240	
260	260	260	98	49	-	25
			100	50	-	30
			168	64	-	35
			216	79	43	40
			240	85	50	45
				99	57	50
				114	65	55
				131	73	60
				150	81	65
				170	90	70
				193	99	75
				219	109	80
				248	120	85
				260	131	90
					144	95
					157	100
					186	110

Product no longer available
 Consult Promat Technical for alternatives

Product no longer available
 Consult Promat Technical for alternatives

Table 3bj. Adhesive fix noggings or welded pin fixings and adhesive board joints when protecting beams.

Beams - Critical steel temperature 620°C

Section factor $AV - m^{-1}$	Fire resistance period - minutes						Beam thickness
	30	60	90	120	180	240	
	260	260	260	168	52	260	20
				235	80	260	30
				260	80	45	30
					95	52	40
					113	62	45
					122	70	50
					154	80	55
					178	90	60
					206	100	65
					237	112	70
					260	124	75
						136	80
						150	85
						165	90
						181	95
						199	100
						238	110

Product no longer available
 Consult Promat Technical for alternatives

Chapter 3: Structural Steel
Timber Column Cladding

Assessment Report CC204497

TIMBER CLADDING

When exposed to fire, most softwoods char at approximately 0.6mm/minute and most hardwoods at about 0.5mm/minute. The fire performance of a timber structural element will obviously depend on these charring rates and the loadbearing capacity of the residual timber.

If the calculated residual strength is inadequate, Promat can offer various solutions normally using Promat UFFULUX® or Promat VERMICULUX® encasements. Please contact the Promat Technical Services Department for more details.

TECHNICAL DATA

1. Concrete or timber column.
2. Promat UFFULUX® or Promat VERMICULUX® board, thickness is determined by fire resistance required and properties of the section to be encased.
3. Fixings into timber could consist of nails or screws, the length of which is determined by the type of timber and the duration of the fire resistance, please consult Promat Technical Services Department.
4. Where protection thickness is greater than 15mm, the boards can be edge fixed to each other avoiding the necessity of fixing to the concrete or timber column. Fixings should penetrate the substrate a minimum of 30mm.

Fig 3.50.1



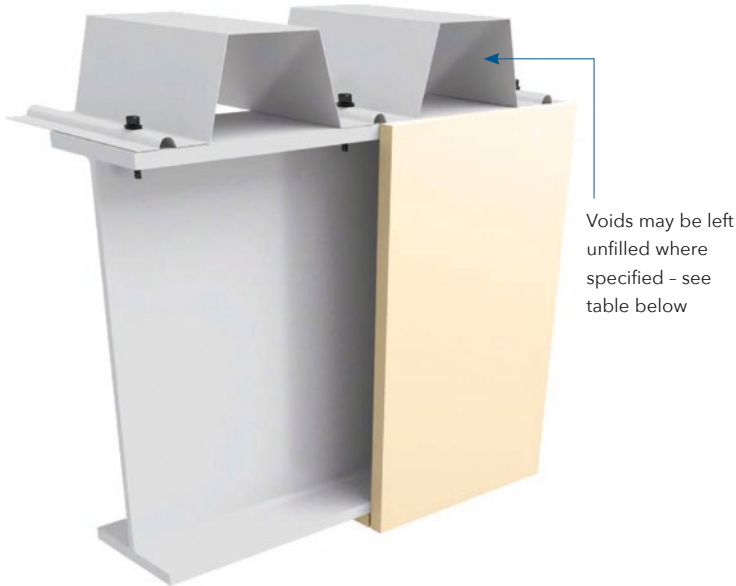
Installation Method - Cladding to timber column.

**Product no longer available
Consult Promat Technical for alternatives**

**Product no longer available
Consult Promat Technical for alternatives**

Design Considerations

Fig 3.60.1



COMPOSITE DECKS

When encasing steel beams supporting composite decks, it is in many cases unnecessary to fill the voids above the top flange of the beam (see table below).

Voids at Compartment Walls

Voids must be filled on beams that are part of a compartment wall, otherwise the integrity and insulation criteria of the wall will be breached. Voids may only be left unfilled on beams that do not form part of a compartment wall.

For decks with the profile running parallel to beams no special recommendations are made for spray applied materials but, for board protection, the boards should be taken past the edge of the flange to abut the underside of the deck.

Trapezoidal Deck				
Beam type	Fire protection on beam	Fire resistance (minutes)		
		Up to 60	90	Over 90
Composite	Materials assessed at 620°C	Increase thickness by 20% or assess thickness using A/V increased by 30%*	Increase thickness by 30% or assess thickness using A/V increased by 50%*	Fill voids
Non-composite	All types	Fill voids above the flange		
* The least onerous option may be used				
Dovetail Decks				
Beam type	Fire protection on beam	Up to 60	90	Over 90
Any	All types	Voids may be left unfilled for all periods of fire resistance		

Note 1: The 'assessed at' temperature relates to that used in the performance assessment document (assessment) for beams subjected to maximum design stress as defined in BS 5950-1: 2000 Structural Use of Steel in Building: Part 1 Code of Practice for Design, for the required fire resistance period.

Chapter 3: Structural Steel

Sprayed Systems, CAFCO® 300

CAFCO® 300

Fire Resistance

CAFCO® 300 is a spray or trowel applied, single package factory controlled pre-mix, based on vermiculite and gypsum, for internal use.

Structures protected with CAFCO® 300 have undergone fire resistance tests up to 240 minutes in approved independent laboratories to recognised standards throughout the world including:

- UK (to BS 476: Parts 6, 7 & 21)
- USA (to ASTM E119)
- France (to l'Arrêté Ministériel August 1979)
- Belgium (to NBN S21-202)
- Germany (to DIN 4102: 1977-09, DIN EN 1363: 1997-10)

The fire resistance test results relate solely to the constructions tested and test conditions imposed.

Fire Protection Thickness

Establishing the Correct Thickness

Refer to the A/V tables on page 43 to page 62 to establish the A/V ratio for a particular beam or column section, or contact the Promat Technical Services Department to ascertain the thickness of CAFCO® 300 that meets the required period of fire resistance for I section beams and H section columns.

For advice on thickness calculations for hollow sections, castellated sections, composite floors, upgrading of concrete slabs and more complex situations please contact the Promat Technical Services Department.

Preparation

Typical Substrates

Unprimed and primed steel, concrete structural frames and return air plenums

Substrate Preparation

The substrate shall be clean, dry and free from dust, loose mill scale, loose rust, oil and any other condition preventing good adhesion. Steelwork and concrete substrates should be covered with Cafco® Bondseal, an adhesive fix coat, prior to the application of CAFCO® 300.

Applications

Installation Steps

Application of CAFCO® 300 must be carried out by an applicator recognised by Promat and applied in accordance with the Installation Guide available from the Promat Technical Services Department.

Methods

Mix CAFCO® 300 with potable water in a suitable mixer and apply by a spraying machine approved by Promat. CAFCO® 300 may also be float finished using conventional hand tools or spray textured.

Application Limitations

CAFCO® 300 may be applied if the substrate ambient temperatures are a minimum of 4°C and rising. It must be maintained for 24 hours before, during and 24 hours after application.

Table 3bn. CAFCO® 300 thicknesses for I section beams and columns. Limiting temperature 620°C

A/V	CAFCO® 300 thickness (mm) for fire resistance of:					
	30 (mins)	60 (mins)	90 (mins)	120 (mins)	180 (mins)	240 (mins)
30	12	12	12	12	16	20
40	12	12	12	13	19	23
50	12	12	12	15	22	26
60	12	12	13	16	24	31
70	12	12	14	18	26	34
80	12	12	15	19	29	36
90	12	12	15	20	29	38
100	12	12	16	21	31	40
110	12	12	17	22	32	41
120	12	12	17	23	33	42
130	12	13	18	23	34	44
140	12	13	18	24	35	46
150	12	13	19	24	35	47
160	12	13	19	25	36	48
170	12	14	20	25	37	48
180	12	14	20	26	37	49
190	12	14	20	26	38	50
200	12	14	20	26	39	51
210	12	14	21	27	39	51
220	12	15	21	27	39	52
230	12	15	21	27	40	52
240	12	15	21	28	40	53
250	12	15	21	28	41	53
260	12	15	22	28	41	54
270	12	15	22	28	41	54
280	12	15	22	29	42	55
290	12	16	22	29	42	55
300	12	16	22	29	42	56
310	12	16	22	29	43	56
320	12	16	23	29	43	56

Table 3bn. CAFCO® 300 thicknesses for I section beams and columns. Limiting temperature 550°C

A/V	CAFCO® 300 thickness (mm) for fire resistance of:					
	30 (mins)	60 (mins)	90 (mins)	120 (mins)	180 (mins)	240 (mins)
30	12	12	12	12	18	23
40	12	12	12	15	21	28
50	12	12	13	17	24	32
60	12	12	14	19	27	35
70	12	12	16	20	29	38
80	12	12	17	21	31	41
90	12	13	18	23	33	43
100	12	13	18	24	34	45
110	12	14	19	25	35	46
120	12	14	20	25	37	48
130	12	14	20	26	38	49
140	12	15	21	27	39	51
150	12	15	21	27	39	52
160	12	15	22	28	40	53
170	12	16	22	28	41	54
180	12	16	22	29	42	55
190	12	16	23	29	42	56
200	12	16	23	30	43	56
210	12	17	23	30	44	57
220	12	17	24	30	44	58
230	12	17	24	31	45	58
240	12	17	24	31	45	59
250	12	17	24	31	45	59
260	12	17	25	32	46	60
270	12	18	25	32	46	60
280	12	18	25	32	46	61
290	12	18	25	32	47	61
300	12	18	25	33	47	62
310	12	18	25	33	47	62
320	12	18	26	33	48	62

Sprayed Systems, Cafco MANDOLITE® CP2

CAFCO MANDOLITE® CP2

Fire Resistance

Structures protected with Cafco MANDOLITE® CP2 have undergone fire resistance tests up to 240 minutes in approved independent laboratories to recognised standards in the following countries:

- UK (to BS 476: Part 21: 1987)
- Germany (to DIN 4102)
- USA (to ASTM E119 UL 263)

The tests also comply with International Standard ISO 834.

Cafco MANDOLITE® CP2 protected structures have been successfully tested under BS 476: Part 21: 1987 to failure temperatures of up to 800°C. This allows the specifier the freedom to adopt a fire engineering approach to fire resistance in accordance with BS 5950: Parts 3 and 8: 1990, as well as the Fire Appendices of the forthcoming Eurocode.

The fire resistance test results relate solely to the constructions tested and test conditions imposed. Promat provides computer based thickness calculations to meet specific fire ratings on receipt of details. See 'Fire Protection Thickness'.

Fire Protection Thickness

Establishing the Correct Thickness

Refer to the A/V tables on [page 43](#) to [page 62](#) to establish the A/V ratio for a particular beam or column section, or contact the Promat Technical Services Department. Then use Tables 3bo and 3bp below to ascertain the thickness of Cafco MANDOLITE® CP2 that meets the required period of fire resistance for I section beams and H section columns.

For advice on thickness calculations for hollow sections, castellated sections, composite floors, upgrading of concrete slab and more complex situations, please contact the Promat Technical Services Department.

Cafco MANDOLITE® CP2 is a spray applied single package, factory controlled pre-mix, based on vermiculite and portland cement for internal use.

Table 3bo. Cafco MANDOLITE® CP2 thicknesses for beams and columns. Limiting temperature 620°C.

A/V	Cafco MANDOLITE® CP2 thickness (mm) for fire resistance of:					
	30 (mins)	60 (mins)	90 (mins)	120 (mins)	180 (mins)	240 (mins)
30	8	8	8	11	15	20
40	8	8	10	13	19	24
50	8	8	11	15	21	28
60	8	9	12	16	23	31
70	8	10	13	17	25	33
80	8	10	14	19	27	35
90	8	11	15	20	28	37
100	8	11	16	20	30	39
110	8	11	16	21	31	40
120	8	12	17	22	32	42
130	8	12	17	22	33	43
140	8	13	18	23	33	44
150	8	13	18	24	34	45
160	8	13	19	24	35	46
170	8	13	19	24	35	46
180	8	14	19	25	36	47
190	8	14	19	25	37	48
200	8	14	20	25	37	49
210	8	14	20	26	37	49
220	8	14	20	26	38	50
230	8	14	20	26	38	50
240	8	15	21	27	39	51
250	9	15	21	27	39	51
260	9	15	21	27	39	51
270	9	15	21	27	40	52
280	9	15	21	27	40	52
290	9	15	21	28	40	53
300	9	15	21	28	40	53
310	9	15	22	28	41	53

Table 3bp. Cafco MANDOLITE® CP2 thicknesses for beams and columns. Limiting temperature 550°C.

A/V	Cafco MANDOLITE® CP2 thickness (mm) for fire resistance of:					
	30 (mins)	60 (mins)	90 (mins)	120 (mins)	180 (mins)	240 (mins)
30	8	8	10	13	18	24
40	8	10	12	15	22	29
50	8	10	14	17	25	32
60	8	11	15	19	27	36
70	8	11	16	20	29	38
80	8	12	17	21	31	40
90	8	13	18	23	32	42
100	8	13	18	23	34	44
110	9	14	19	24	35	45
120	9	14	19	25	36	47
130	9	14	20	25	37	48
140	9	15	20	26	37	49
150	9	15	21	26	38	50
160	9	15	21	27	39	51
170	9	15	21	27	39	51
180	10	16	22	28	40	52
190	10	16	22	28	40	53
200	10	16	22	28	41	53
210	10	16	22	29	41	54
220	10	16	23	29	42	54
230	10	16	23	29	42	55
240	10	17	23	29	42	55
250	10	17	23	30	43	56
260	10	17	23	30	43	56
270	10	17	23	30	43	56
280	10	17	24	30	43	56
290	10	17	24	30	44	57
300	10	17	24	31	44	57
310	11	17	24	31	44	58

Chapter 3: Structural Steel

Sprayed Systems, Cafco MANDOLITE® CP2

Preparation

Typical Substrates

Unprimed and primed steel, concrete frames, metal floor/roof decks, and return air plenums.

Substrate Preparation

The substrate shall be clean, dry and free from dust, loose millscale, loose rust, oil and any other condition preventing good adhesion. Cafco MANDOLITE® CP2 can be applied directly on to clean bare 'ginger' steel.

All other conditions will require some form of preparation. The surface may simply require degreasing, de-scaling or the removal of loose rust to restore the surface condition to those above, but all other situations will require some preparation before Cafco MANDOLITE® CP2 can be applied. Please contact Promat Technical Services for further information.

Mesh Reinforcement

Most fire tests conducted have been carried out without mesh reinforcement, to demonstrate the ability of Cafco MANDOLITE® CP2 to stay in place under the most severe fire conditions. However, in areas where vibration or excessive movement is required Cafco MANDOLITE® CP2 will need to be applied over Cafco PSK-101 and will require mesh reinforcement.

Application

Initial Steps

Application of Cafco MANDOLITE® CP2 must be carried out by an applicator recognised by Promat and applied in accordance with the Installation Guide available from the Promat Technical Services Department.

Methods

Mix Cafco MANDOLITE® CP2 with potable water in a suitable mixer and apply by a spraying machine approved by Promat. Cafco MANDOLITE® CP2 may be centrally pumped vertically or horizontally, enabling all spray plant and material storage to be contained in one area.

Application Limitations

Cafco MANDOLITE® CP2 may be applied when the substrate and air temperatures are at least 2°C and rising, but should not be applied if the substrate or air temperatures are less than 4°C and falling. Maximum air and substrate temperature is 45°C. Substrate temperature should be at least 2°C above dewpoint temperature.

Topcoating

General Considerations

CAFECO® MANDOLITE® CP2 can be painted with finishes that are suitable for direct application onto concrete substrates. Please contact Promat Technical Services for further information.

Sprayed Systems, Cafco FENDOLITE® MII

CAFCO FENDOLITE® MII

Fire Resistance

Structures protected with Cafco FENDOLITE® MII have undergone fire resistance tests in approved independent laboratories to recognised standards in the UK to BS 476: Part 21: 1987.

The fire resistance test results relate solely to the constructions tested and test conditions imposed. The Promat Technical Services Department provides computer based thickness calculations to meet specific fire ratings on receipt of details. See 'Fire Protection Thickness'.

Cafco FENDOLITE® MII protected structures have been successfully tested under BS 476: Part 21: 1987 to failure temperatures of up to 800°C. This allows the specifier the freedom to adopt a fire engineering approach to fire resistance in accordance with BS 5950: Parts 3 and 8: 1990, as well as the Fire Appendices of the forthcoming Eurocode.

Fire Protection Thickness

Establishing the Correct Thickness

Refer to the A/V tables on [page 43](#) to [page 62](#) to establish the A/V ratio for a particular beam or column section, or contact the Promat Technical Services Department. Then use Tables 3bq and 3br below to ascertain the thickness of Cafco FENDOLITE® MII that meets the required period of fire resistance for I section beams and H section columns.

For advice on thickness calculations for hollow sections, castellated sections, composite floors, upgrading of concrete slab and more complex situations, please contact the Promat Technical Services Department.

Cafco FENDOLITE® MII is a spray applied single package, factory controlled pre-mix, based on vermiculite and portland cement.

Table 3bq. Cafco FENDOLITE® MII thicknesses for beams and columns. Limiting temperature 620°C.

A/V	Cafco FENDOLITE® MII thickness (mm) for fire resistance of:					
	30 (mins)	60 (mins)	90 (mins)	120 (mins)	180 (mins)	240 (mins)
30	8	8	8	9	13	18
40	8	8	8	11	17	23
50	8	8	9	12	20	27
60	8	8	10	14	22	30
70	8	8	11	16	24	33
80	8	8	12	17	26	36
90	8	8	13	18	28	38
100	8	8	14	19	30	40
110	8	9	14	20	31	42
120	8	9	15	21	32	44
130	8	9	15	22	34	46
140	8	10	16	22	35	47
150	8	10	16	23	36	49
160	8	10	17	24	37	50
170	8	10	17	24	38	51
180	8	11	18	25	39	52
190	8	11	18	25	39	54
200	8	11	18	26	40	55
210	8	11	19	26	41	55
220	8	11	19	26	41	56
230	8	12	19	27	42	57
240	8	12	19	27	43	58
250	8	12	20	28	43	-
260	8	12	20	28	44	-
270	8	12	20	28	44	-
280	8	12	20	28	44	-
290	8	12	21	29	45	-
300	8	13	21	29	45	-
310	8	13	21	29	46	-

Table 3br. Cafco FENDOLITE® MII thicknesses for beams and columns. Limiting temperature 550°C.

A/V	Cafco FENDOLITE® MII thickness (mm) for fire resistance of:					
	30 (mins)	60 (mins)	90 (mins)	120 (mins)	180 (mins)	240 (mins)
30	8	8	8	11	17	23
40	8	8	10	14	21	28
50	8	8	11	16	24	32
60	8	8	13	17	27	36
70	8	9	14	19	29	39
80	8	10	15	20	31	42
90	8	10	16	22	33	44
100	8	11	17	23	35	47
110	8	11	17	24	36	49
120	8	12	18	24	37	50
130	8	12	19	25	39	52
140	8	12	19	26	40	53
150	8	13	20	27	41	55
160	8	13	20	27	42	56
170	8	13	20	28	42	57
180	8	13	21	28	43	58
190	8	14	21	29	44	-
200	8	14	21	29	45	-
210	8	14	22	30	45	-
220	8	14	22	30	46	-
230	8	14	22	30	46	-
240	8	14	23	31	47	-
250	8	15	23	31	47	-
260	8	15	23	31	48	-
270	8	15	23	32	48	-
280	8	15	23	32	49	-
290	8	15	24	32	49	-
300	8	15	24	32	49	-
310	8	15	24	33	50	-

Chapter 3: Structural Steel

Sprayed Systems, Cafco FENDOLITE® MII

Preparation

Typical Substrates

Unprimed and primed steel, concrete structural frames, metal decks, and return air plenums.

Substrate Preparation

The substrate shall be clean, dry and free from dust, loose millscale, loose rust, oil and any other condition preventing good adhesion. Cafco FENDOLITE® MII can be applied directly on to clean bare 'ginger' steel.

All other conditions will require some form of preparation. The surface may simply require degreasing, de-scaling or the removal of loose rust to restore the surface condition to those above, but all other situations will require some preparation before Cafco FENDOLITE® MII can be applied. Please contact Promat Technical Services for further information.

Mesh Reinforcement

Most fire tests conducted have been carried out without mesh reinforcement, to demonstrate the ability of Cafco FENDOLITE® MII to stay in place under the most severe fire conditions. However, in areas where vibration or excessive movement is required Cafco FENDOLITE® MII will need to be applied over Cafco PSK-101 and will require mesh reinforcement.

Application

Initial Steps

Application of Cafco FENDOLITE® MII must be carried out by an applicator recognised by Promat and applied in accordance with the Installation Guide available from the Promat Technical Services Department.

Methods

Mix Cafco FENDOLITE® MII with potable water in a suitable mixer and apply by a spraying machine approved by Promat. Cafco FENDOLITE® MII may be float finished using conventional hand tools or spray textured.

Application Limitations

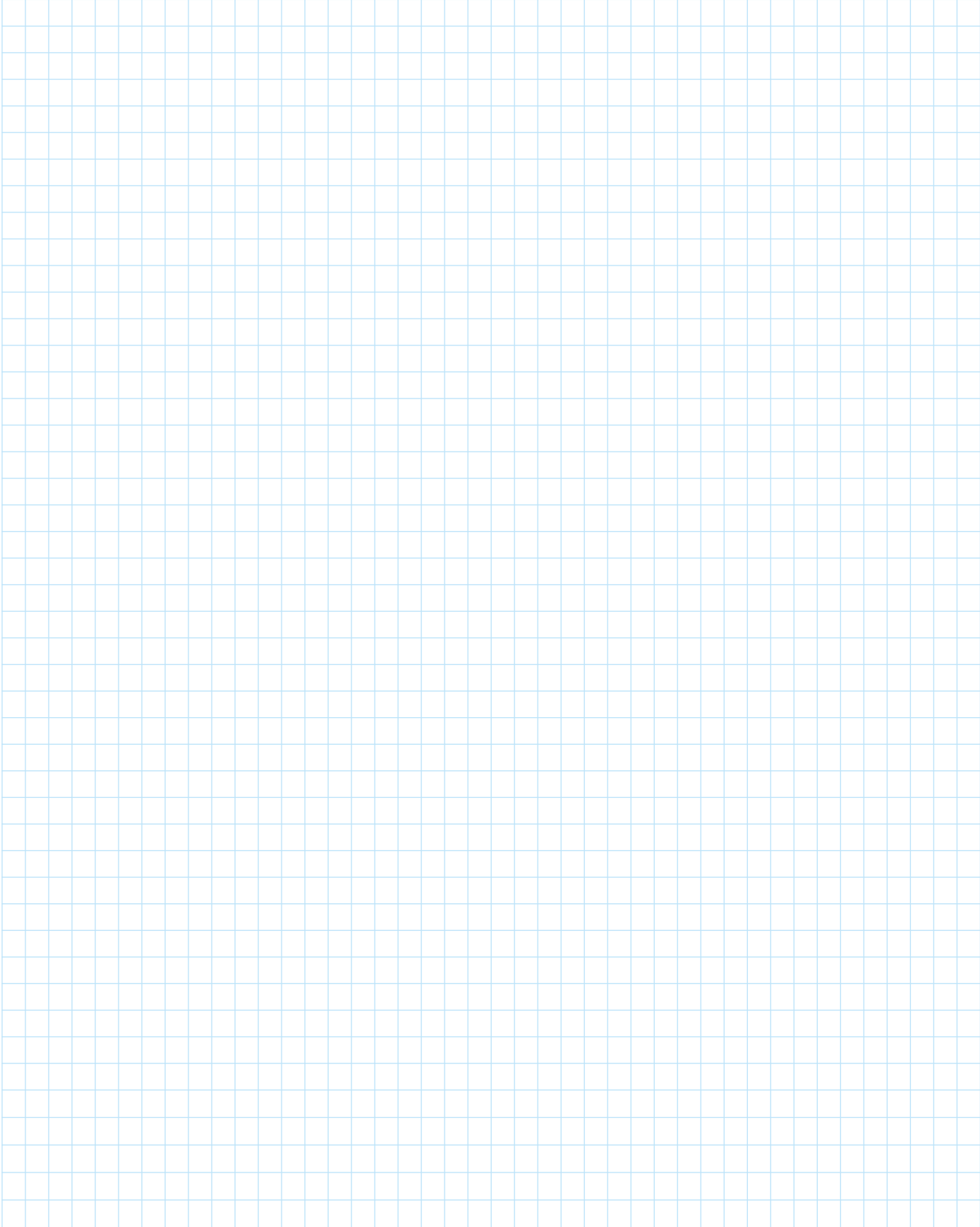
Cafco FENDOLITE® MII may be applied when the substrate and air temperatures are at least 2°C and rising, but should not be applied if the substrate or air temperatures are less than 4°C and falling. Maximum air and substrate temperature is 45°C. Substrate temperature should be at least 2°C above dewpoint temperature.

Topcoating

General Considerations

CAFECO® FENDOLITE® MII can be painted with finishes that are suitable for direct application onto concrete substrates. Please contact Promat Technical Services for further information.

Notes



GB ORDERLINE

For placing orders, delivery enquiries
and local stockists etc.

T: 0800 373 636

F: 01275 379 037

E: orderline@etexbp.co.uk

TECHNICAL SERVICES

For technical support and advice.

T: 0800 145 6033

E: technical.promat@etexbp.co.uk

RESOLUTIONS

For any problems with invoices or deliveries.

T: 01275 379 031 or 0800 373 636

E: customer.support@etexbp.co.uk

Etex Building Performance Limited

Marsh Lane, Easton-in-Gordano,

Bristol, BS20 0NE

T: 0800 373 636 F: 01275 379 037

promat.com

© 2022 Etex Building Performance Limited

V4 14/06/2022