

Promat

The Passive Fire Protection Handbook

The UK's comprehensive guide
to passive fire protection

Chapter 6 Fire Rated Ductwork and Service Enclosures

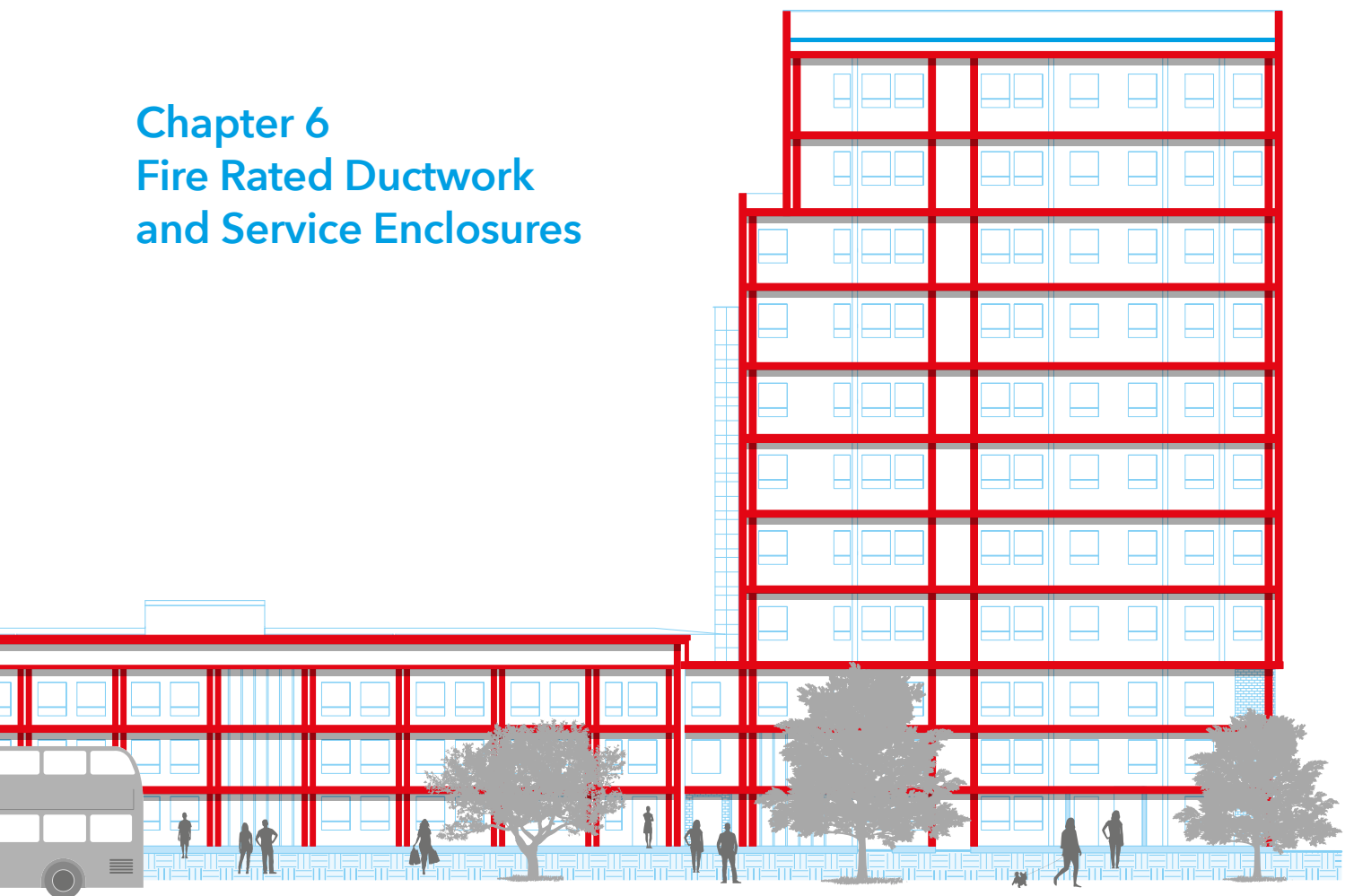

FEBRUARY 2023



Contents

**Chapter 6: Fire Rated
Ductwork and Service Enclosures..... 6.1**

Ventilation and Smoke

Extraction Ducts6.2

Self-Supporting Ducts6.7

DURADUCT® SMT Fireblast6.10

Cable Protection6.12

Cable Protection - External or
Internal Fires6.16

Service Enclosures6.17

Horizontal Service
Enclosures, Suspended Services6.18

DURASTEEL Horizontal
Service Enclosure,
Suspended Services6.19

Fire Rated Ductwork and Service Enclosures

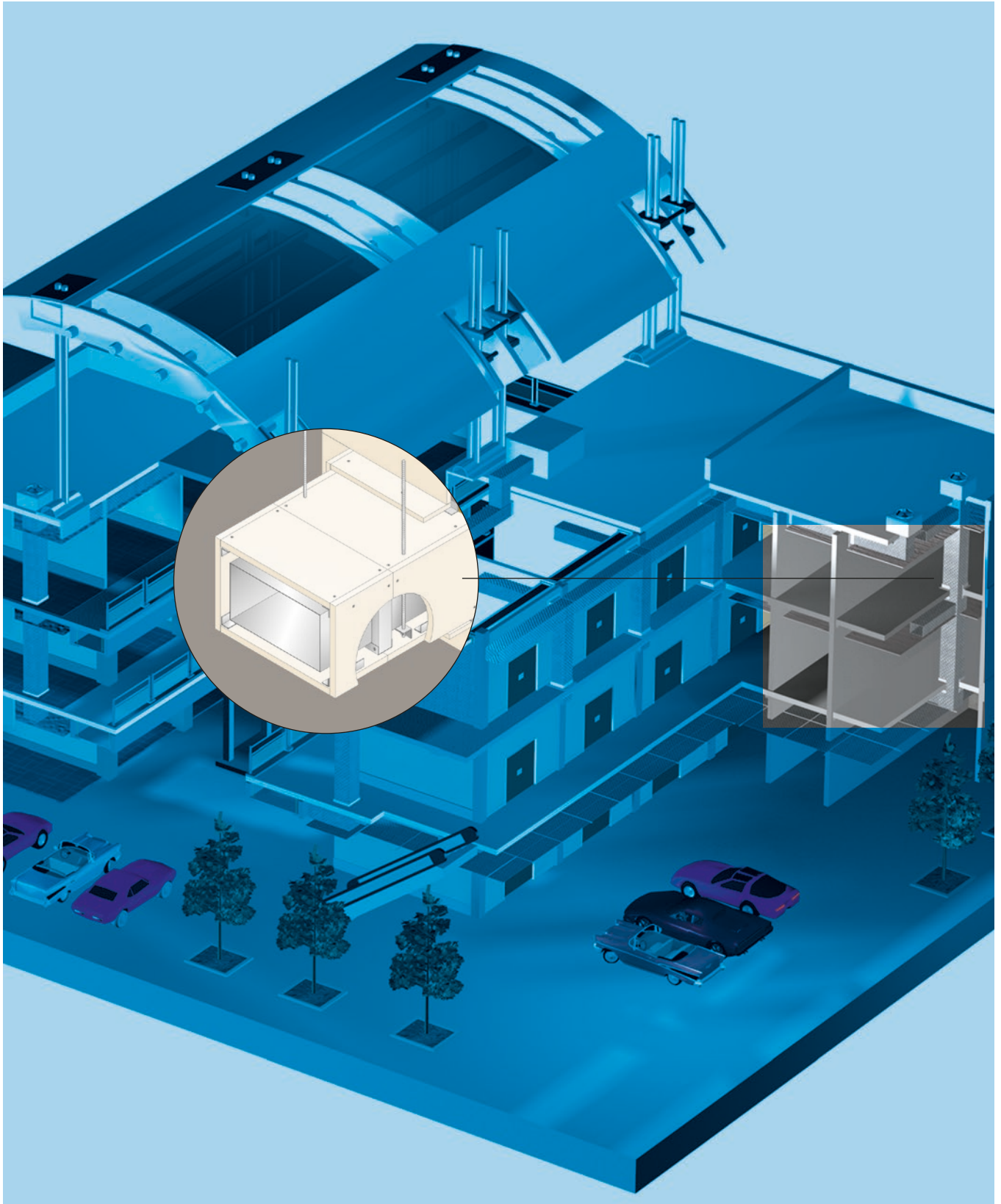

Ventilation and Smoke Extraction Ducts

The relative complexity of any ductwork system which is passing through different fire compartments and the relevance of the system's function in ambient and fire conditions can make the selection of a suitable ductwork system difficult.

This section of the handbook aims to give guidance on the fire performance requirements of ductwork and offers a wide range of solutions for proprietary "off the shelf" fire rated ductwork, the protection of steel ductwork and for self-supporting systems using Promat PROMATECT®-L500.

For particularly onerous conditions e.g. where a high impact strength is required or for use in aggressive environments, Promat have developed a range of systems using Promat DURASTEEL®.

FIRE TESTING METHODS

To determine the fire resistance of ducts (without the aid of fire dampers) passing through or between compartments, the system should normally be tested or assessed in accordance with BS 476: Part 24: 1987. This standard has been written specifically for ventilation ducts, but guidance is also given in the standard on the performance requirements for 'smoke outlet' ducts and 'kitchen extract' ducts.

Tested duct systems are exposed to external fire (Duct A) and internal fire (Duct B). Fans create a standard pressure difference and air flow and the ducts fire performance is assessed in both the fan-on and the fan-off situations. When testing horizontal ducts, a run of at least 3m is located within the fire compartment and a further 2.5m outside the fire compartment.

BS 476: Part 24: 1987 expresses the fire resistance of ducts without the aid of dampers, in terms of stability, integrity and insulation. Stability failure occurs when the suspension or fixing devices can no longer retain a duct in its intended position or when sections of the duct collapse. This requirement does not apply to the length of the duct exposed to internal fire (Duct B) within the fire compartment.

Integrity failure occurs when cracks, holes or openings occur in the duct or at any penetrations through walls or floors, which flames or hot gases can pass. The effects on integrity of the movement and distortion of both restrained and unrestrained ducts are also included in the standard.

Insulation failure occurs when the temperature rise on the outer surface of the duct, outside the fire compartment, exceeds 140°C (mean) or 180°C (maximum). The guidance in the standard also states that ducts lined with combustible materials or coated internally with fats or greases e.g. kitchen extract, should also have this criterion for the inner surface of the duct within the fire compartment when the duct is exposed to external fire (Duct A).

For smoke extraction, the guidance in the standard states that the cross sectional area of a duct required to extract smoke in the event of a fire should not be reduced by more than 25%.

DESIGN CONSIDERATIONS

The following points are some of the factors which should be considered when determining the correct specification to ensure a ductwork system will provide the required fire performance. Further advice can be obtained from the Promat Technical Services Department.

1. Required Fire Exposure

Ductwork systems which are located in more than one compartment should always be tested or assessed for their performance when exposed to the heating conditions of BS 476: Part 20: 1987. Reduced heating curves are generally only acceptable for certain components of the system e.g. the fan. The performance of a ductwork system will vary depending on whether or not a fire could have direct access to inside the duct through an unprotected opening. If in doubt, one should assume it can i.e. the Duct B scenario described previously under Fire Testing Methods.

2. Required Fire Performance

It is normally required to satisfy all the relevant performance criteria of stability, integrity and insulation (and cross sectional area if a smoke extraction duct). However, the approval authority may accept a relaxation on occasions. For example, if no combustible materials or personnel could be in contact with the duct, the authority may accept a reduced insulation performance.

Ventilation and Smoke Extraction Ducts

3. Supporting Structure

Any structural element that the ductwork system is supported from e.g. a beam, floor or wall, must have at least the same fire resistance as the duct system itself.

4. Hanger Support

The hangers, supports and their fixings should be capable of bearing the load of the complete ductwork system including any applied insulation material or other services suspended from it. Chemical anchors are not generally suitable. It is generally not advisable to use unprotected supports if the stress exceeds the values given on page 6.7 and/or if hanger lengths exceed 2m. The hanger centres should not exceed the limits given in the following pages for the relevant system.

5. Steel Ductwork

The steel duct must be constructed in accordance with the requirements of DW144 - Specification for sheet metal ductwork (published by the Heating and Ventilating Contractors' Association), or equivalent specification.

6. Penetrations through Walls and Floors

Care should be taken to ensure that movement of the duct in ambient or in fire conditions does not adversely affect the performance of the wall, partition or floor, or any penetration seal.

7. Movement Joints

Movement joint details may be required for long lengths of duct, particularly where the duct spans across a movement joint in the floor or wall, or passes through floors or a roof that may deflect at different rates.

8. Air Flow and Leakage

The design of some fire resisting duct systems may need modification to meet DW144 performance standards.

9. Ductwork Functions

Most ductwork systems can fall into one or more of the following categories:

- Ventilation and air conditioning
- Natural smoke extract
- Fan assisted smoke extract
- Pressurisation of escape routes and fire fighting lobbies
- Non-domestic kitchen extract.

In the event of a fire, the function of a system can often alter. For example, an air conditioning system could switch to become a fan assisted smoke extract duct. It is therefore essential that the performance requirements in both normal conditions and fire conditions are considered.

10. Other Requirements

Acoustic performance, thermal insulation, water tolerance, strength and appearance can also be important considerations.



SELECTION OF FIRE PROTECTION SYSTEM

Traditionally all ductwork was fabricated from steel which normally had to be encased in a fire protection system when passing through a compartment wall or floor without the aid of a fire damper.

In recent years, self-supporting systems without a steel liner have been introduced to extract smoke in the event of a fire through natural ventilation, and now self-supporting systems e.g. Promat PROMATECT®-L500 and Promat DURASTEEL®, are available which can match the leakage and air flow performance of steel ducts in accordance with DW144 up to Class C.

To satisfy the wide range of requirements in the current market, Promat offers a number of products to protect steel ductwork and to fabricate self supporting duct systems.

The system selector on the next page should assist in determining the correct ductwork system to meet your needs and further guidance can be obtained from the Promat Technical Services Department.

Chapter 6: Fire Rated Ductwork and Service Enclosures

Ventilation and Smoke Extraction Ducts

DESIGNER SELECTOR TABLE

Table 6b Self-Supporting Ducts

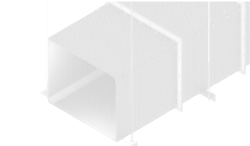
	Product	Advantages	Maximum Pressure Classification***	Maximum Duct Size (mm)** (width x height)
 CERTIFIRE CF423	Promat PROMATECT®-L500 Lightweight calcium silicate boards, off-white colour, stapled or screwed and glued to each other.	Appearance Non-combustible Water tolerant	HIGH PRESSURE Class C	3000 x 1250
 CERTIFIRE CF480	Promat DURASTEEL® Very robust panels with cement based core and outer steel linings, screw fixed to steel framework. All joints filled with Promat PROMASEAL® sealant.	High impact strength Non-combustible Water tolerant	HIGH PRESSURE Class C****	6000 x 1250

** With modifications to system
 *** Maximum static pressure classification as defined by DW144
 **** Promat DURASTEEL® SMT requires internal steel liner

Assessment under review
 Please contact Promat Technical team for further information

Table 6d Self-Supporting Ducts

Product	Remarks
Promat PROMATECT®-L500 CERTIFIRE CF423	Insulation quoted for Duct Type B. Exposed to external and internal fire.
Promat DURADUCT® LT Certifire CF480	Insulation quoted for Duct Type B. Exposed to external and internal fire. Natural ventilation/ powered ventilation/ smoke extraction. Insulation applied when necessary.
	Kitchen extract
Promat DURADUCT® SMT Certifire CF480	Insulation quoted for Duct Type B. Exposed to external and internal fire. Natural ventilation/ powered ventilation/ smoke extraction. Insulation applied when necessary.
	Kitchen extract

Assessment under review
 Please contact Promat Technical team for further information

HANGERS

Each hanger consists of two threaded rods and an angle or channel section. The hangers may be unprotected provided the rods are not more than 50mm from duct side walls and the stress in the hangers does not exceed the values given in the tables 6e and 6f. When hangers exceed 2000mm in length they should be clad with material of similar thickness to the duct to prevent excessive thermal expansion.

When hangers are suspended from protected steel beams it is advisable that the hanger rods should be protected for at least 300mm from the beams with the same level of protection as the structural beams.

Vertical duct runs normally require to be tied back to an adjoining masonry wall using threaded rods and angle or channel support section at maximum 3000mm centres.

GENERAL DESCRIPTION

For any size of duct, the tensile stress in the steel hangers must not exceed the maximum permitted stress for each fire resistance period based on BS 5950: Part 8: 2003.

If these stress levels are exceeded then the size of the hanger rods must be increased, or the centres of the hangers reduced or the hangers protected. The penetration of the hanger fixings into any concrete soffit should be a minimum of 50mm for 120 minutes ratings or 65mm for 240 minutes ratings.

Table 6e Maximum Permitted Stress

Fire resistance period (minutes)	Approximate Temperature °C	Maximum Permitted Stress (N/mm ²)
30	840	18
60	950	15
90	1000	10
120	1050	10
180	1100	6
240	1150	6

Table 6f Maximum Loads For Threaded Drop Rods

Nominal diameter (mm)	Tensile stress area (BS 4190) (mm ²)	Load					
		60 minutes (15N/mm ²)		120 minutes (10N/mm ²)		240 minutes (6N/mm ²)	
		(kN)	(kg)	(kN)	(kg)	(kN)	(kg)
6	20.1	0.30	30.73	0.20	20.49	0.12	12.29
8	36.6	0.55	55.96	0.37	37.31	0.22	22.39
10	58.0	0.87	88.69	0.58	59.12	0.35	35.47
12	84.3	1.26	128.90	0.84	85.93	0.51	51.56
16	157.0	2.36	240.06	1.57	160.04	0.94	96.02
20	245.0	3.68	374.62	2.45	249.75	1.47	149.85

Chapter 6: Fire Rated Ductwork and Service Enclosures
Self-Supporting Ducts

Certifire Approval No CF 423

Table 6k Fire Outside (Duct A)

Maximum duct pressure (Pa)	Fire resistance (minutes)		Board thickness (mm)	Maximum internal dimensions of duct (mm)	Stiffeners	
	Stability & Integrity	Insulation			Method 1	Method 2
± 500	240	120	25	1200 x 1200		
± 500	240	120	25	2000 x 1250	1 row	1 row
± 500	240	120	25	3000 x 1250	2 rows	2 rows
± 750	240	180	40	1200 x 1200		
± 750	240	180	40	2000 x 1250	1 row	1 row
± 750	240	180	40	3000 x 1250	2 rows	2 rows
± 750	240	240	52	1200 x 1200	1 row	1 row
± 750	240	240	52	2000 x 1250	2 rows	2 rows
+ 1000/- 2000	240	180	40	800 x 600		
+ 1000/- 2000	240	180	40	1440 x 700		1 row
+ 1000/- 2000	240	180	40	1800 x 600	2 rows	
+ 1000/- 2000	240	180	40	1440 x 700		1 row
+ 1000/- 2000	240	240	52	1800 x 600	2 rows	

Table 6l Fire Inside (Duct B)

Maximum duct pressure (Pa)	Fire resistance (minutes)		Board thickness (mm)	Maximum internal dimensions of duct (mm)	Stiffeners	
	Stability & Integrity	Insulation			Method 1	Method 2
± 500	240	30	25	1200 x 1200		
± 500	240	30	25	2000 x 1250	1 row	1 row
± 500	240	30	25	3000 x 1250	2 rows	2 rows
± 500	240	60	35	1200 x 1200		
± 500	240	60	35	2000 x 1250	1 row	1 row
± 500	240	60	35	3000 x 1250	2 rows	2 rows
± 750	240	90	40	1200 x 1200		
± 750	240	90	40	2000 x 1250	1 row	1 row
± 750	240	90	40	3000 x 1250	2 rows	2 rows
± 750	240	120	52*	1200 x 1200		
± 750	240	120	52*	2000 x 1250	1 row	1 row
± 750	240	120	52*	3000 x 1250	2 rows	2 rows
+ 1000/- 2000	240	90	40	800 x 600		
+ 1000/- 2000	240	90	40	1440 x 700		1 row
+ 1000/- 2000	240	90	40	1800 x 600	2 rows	
+ 1000/- 2000	240	120	52*	800 x 600		
+ 1000/- 2000	240	120	52*	1440 x 700		1 row
+ 1000/- 2000	240	120	52*	1800 x 600	2 rows	

* To achieve 240 minutes insulation add 50mm rock wool 100 kg/m³ density.
 Note: For greater operating pressures and larger ducts please contact Promat Technical Services Department.

Chapter 6: Fire Rated Ductwork and Service Enclosures

Self-Supporting Ducts

Certifire Approval No CF 480

PROMAT PROMATECT®-L500

The Promat PROMATECT®-L500 self-supporting system provides an economical and fire safe method of constructing natural and mechanical smoke extract and ventilation ductwork without a steel lining. Lengths of the Promat PROMATECT®-L500 system may be prefabricated reducing disruption to other trades on site.

For selection of board thickness, it will not only depend on the required fire performance but also on the internal cross section of the duct and the operating pressure(s). With large ducts and medium to high operating pressures, internal stiffeners may be required.

Tables 6k and 6l opposite give guidance on these requirements and further assistance is available from the Promat Technical Services Department.

TECHNICAL DATA

Up to 240 minutes fire rating, stability, integrity and insulation in accordance with the criteria of BS 476: Part 24: 1987.

1. Promat PROMATECT®-L500 board, thickness in accordance with Table 6k or 6l (opposite). If guidance in Table 6k or 6l requires stiffeners to be used, please refer to details 4 and 5 on page 6.9.
2. Promat SUPALUX® strips, 100mm wide x 9mm thick.
3. Promat VICUBOND® WR adhesive in all joints. (Promat PROMASEAL® paint may be used on high pressure ducts to seal joints).
4. Steel angle minimum 30mm x 30mm x 3mm thick, at maximum 1250mm centres, sized according to duct size and weight and maximum permitted stress levels.
5. Threaded steel rod with hexagonal nuts, sized in accordance with table on page 6.6.
6. Steel wire staple (steel) step through screws as shown in table 6m below.
7. Optional angle trim.

Table 6m

Board thickness (mm)	Screws at 200mm centres	Staples at 100mm centres
9	25mm x No.6	28/10/1.0-
25	50mm x No.6	63/11/1.5
30	63mm x No.8	63/11/1.5
35	63mm x No.8	70/12/2
40	75mm x No.8	80/12/2
52	100mm x No.10	90/12.2/2.3

Detail 1 - Duct support

The duct must be supported at maximum 1250mm centres, located to coincide with joints, or to be within 50mm of the joint. For duct sections more than 1250mm in length, an additional hanger is required at the mid-point of the section.

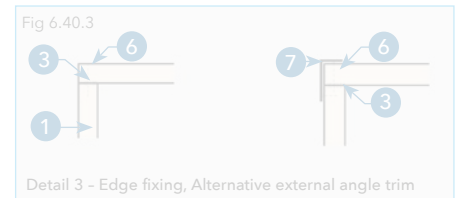
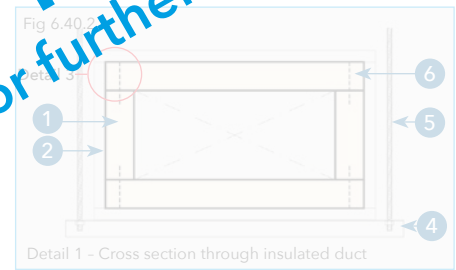
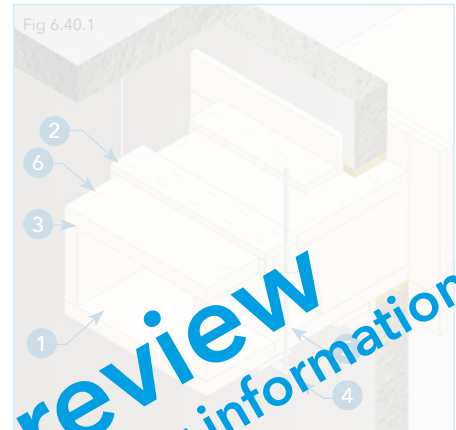
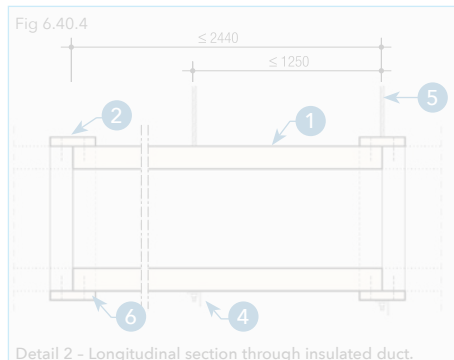

Assessment under review
Please contact Promat Technical team for further information

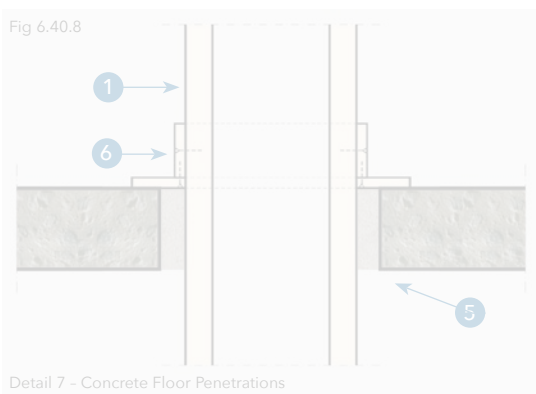
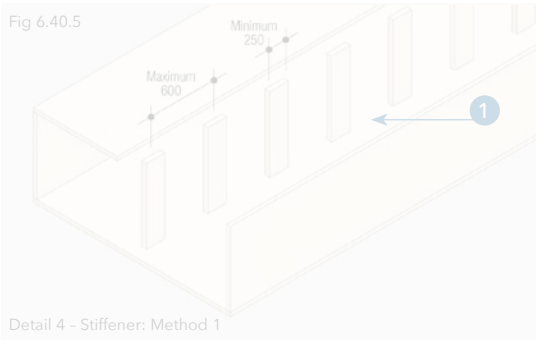

PROMAT PROMATECT®-L500

Maximum Duct Size and Operating Pressures

The basic duct design shown on page 6.8 is adequate for ducts with a maximum internal cross-section of 1200mm x 1200mm for operating pressures up to ± 500 Pa.

This limit can be increased to ± 750 Pa if the board thickness is 40mm or greater. For larger ducts and greater operating pressures, stiffeners are required using either of the methods shown in Details 4 and 5 (also see Tables 6k and 6l on pages 6.7).

For either method, the minimum stiffener thickness is 40mm.

Detail 4 - Stiffener: Method 1

Stiffeners are constructed with strips of Promat PROMATECT®-L500, 250mm wide, fixed at maximum 600mm centres.

Detail 5 - Alternative Stiffener: Method 2

The duct (1) is substituted by a solid Promat PROMATECT®-L500 board, with holes cut into the wall of duct and quantity to ensure equal crossflow of air between the two halves.

Detail 6 - Masonry Wall Penetrations

The duct (1) should pass through the wall opening without interruption. The penetration is sealed with rock wool of minimum density 60kg/m³ (3). A Promat PROMATECT®-L500 L-shape collar (2) fabricated from minimum 80mm x 80mm x 20mm thick, should be fixed to the duct only, on all four sides.

Insert approximately 30mm of rock wool (4) between the solid wall and cover angle. For penetrations through lightweight framed partitions, please consult the Promat Technical Services Department.

Detail 7 - Concrete Floor Penetrations

The duct (1) should pass through the floor opening without interruption and the gap is sealed with Promat PROMASEAL® Compound (5). Secure Promat PROMATECT®-L500 L-shaped reinforcement collars (6) fabricated from minimum 80mm x 80mm x 20mm thick to the duct, to transfer the load of duct to the floor.

Note: Collars should be bonded with Promat Vicubond WR®.

Please contact Promat Technical team for further information

DURADUCT® SMT Fireblast

Certifire Approval No CF 480

CONSTRUCTION

The SMT system is formed by fixing 9.5mm Promat DURASTEEL® sheets on to a welded, prefabricated steel skeletal framework, minimum 3mm thick. The sheets are fixed using self-drilling self-tapping screws, with Promat PROMASEAL® sealant applied before fixing to the frame. Flanged lengths of ductwork are bolted together trapping Promat PROMASEAL® sealant between the mating flanges. The SMT system can be constructed in 1, 2, 3 or 4 sided configurations.

TYPICAL APPLICATIONS

Promat DURADUCT® SMT Fireblast has been tested to provide high levels of blast and fire protection making the system uniquely suitable for potentially explosive environments such as electrical transformer and switch gear rooms.

Promat DURADUCT® SMT is also tried and tested in ductwork solutions for smoke control, smoke exhaust, fresh air ventilation, kitchen extraction, fire protection of building services, pressurisation riser shafts, lift-shaft protection and protection of power cables and services.

PERFORMANCE

Up to 240 minutes fire resistance in accordance with the integrity and insulation criteria of BS 476: Part 24:1987.



Promat DURADUCT® SMT may be constructed in 1, 2, 3 or 4 sided versions



Assessment under review
Please contact Promat Technical team for further information

Table 6o Ductwork Insulation Matrix - Promat DURADUCT® SMT System					
Applications		Powered ventilation/Natural ventilation/Smoke extraction/Kitchen extract			
Notes		All ductwork is tested/assessed to BS 476: Part 24: 1987 (ISO 6944-1985) Type A duct - External fire condition Type B duct - Internal fire condition			
Natural Ventilation / Powered Ventilation / Smoke Extract					
Minutes	Stability	Integrity	Type A or B duct - 300°C smoke temperature	Rock Wool Insulation	
				Type A duct - 1000°C+	Type B duct - 1000°C+
30	Yes	Yes	SMT	SMT	SMT
60	Yes	Yes	SMT	SMT + 30mm of 60 kg/m ³	SMT + 50mm of 60 kg/m ³
120	Yes	Yes	SMT	SMT + 50mm of 60 kg/m ³	SMT + 80mm of 140 kg/m ³
180	Yes	Yes	SMT	SMT + 50mm of 140 kg/m ³	SMT + 100mm of 140 kg/m ³
240	Yes	Yes	SMT	SMT + 90mm of 165 kg/m ³	SMT + 120mm of 140 kg/m ³
Kitchen Extract					
Where main fire risk is from in to out - Type B duct, internal fire condition, use the above table Where main fire risk is from out to in - Type A duct, external fire condition at 1000°C+. Use the table below.					
Minutes	Stability	Integrity	Rock Wool Insulation		
			Type A duct - 1000°C+		
60	Yes	Yes	SMT + 50mm of 165 kg/m ³		
120	Yes	Yes	SMT + 90mm of 165 kg/m ³		
NOTE: It is normally required to satisfy all the relevant performance criteria of stability, integrity and insulation. However, if no combustible materials or personnel could be in contact with the duct the Approval Authority may accept a reduced insulation performance.					

Cable Protection

CABLE PROTECTION

In the event of a fire it may be vital to the safety of the building occupants that certain electrical systems and services remain functioning until all personnel have escaped. Such systems will therefore require protection from fire for a specified period of time and may include:

- Electrically operated fire alarms
- Emergency escape route lighting
- Electrically operated extinguishing systems
- Smoke extraction vent systems
- Power supply for fire service elevators in high-rise buildings
- Water mains to sprinkler systems

In addition to protection from fire outside the duct, it is normally vital that any fire within the duct is contained e.g. if cable sheathing ignites due to an electrical overload.

A suitably designed duct will:

- Prevent the propagation of fire from one building compartment to another
- Assist in maintaining escape routes
- Ensure the continuing operation of other services within a common service shaft
- Reduce damage to localised areas
- Contain smoke and toxic fumes from burning cables

The only fire resistance test standards for cable protection systems which simulate a real fire scenario are the German standards, DIN 4102, "Fire behaviour of building materials and building components", Parts 11 and 12.

Part 11 assesses the encasement system when exposed to a fully developed internal fire. The integrity of the encasement, and any penetrations through walls and floors, are measured, plus the temperature on the outer surface of the duct (140°C mean rise, 180°C maximum rise). The heating curve for DIN 4102: Part 11 is the same as that used in BS 476: Part 20: 1987 and the failure criteria for integrity and insulation are almost identical. The systems detailed are approved for use to provide a performance in accordance with BS 476: Part 20: 1987.

DIN 4102: Part 12 assesses the encasement system when exposed to a fully developed external fire. In addition to the requirement to maintain the integrity of the encasement and any penetrations through walls or floors, the standard requires that:

- a) The cables continue to function for the duration of the exposure period;
- b) The temperature on the cable jacket should not exceed 150°C.

The tested encasement system protects a wide range of different cable types.

Power is passed through the cables throughout the test.

As an added safety factor, the systems described in this section will ensure that the temperature on the cable jacket does not exceed 120°C.

NOTE: Fibre optic cables have a lower failure temperature and therefore the Promat Technical Services Department should be consulted to determine the required board thickness.

DESIGN CONSIDERATIONS

The following points are some of the factors which should be considered when determining the correct specification to ensure the cable duct system will provide the required fire performance. Further advice can be obtained from the Promat Technical Services Department.

1. Required Fire Exposure

The specification of a cable duct system will depend on whether it is expected to resist external fire, internal fire, or both.

2. Required Fire Performance

Generally, the most onerous requirement is to maintain the integrity of the circuit(s) when the system is exposed to external fire. If this is not needed, the performance requirements may be reduced by the approval authority to provide only stability, integrity and insulation of the duct system and/or the wall and floor penetrations.

On occasions further relaxations may be approved e.g. a reduced insulation performance can sometimes be acceptable if no combustible materials or personnel will be in contact with the duct.

3. Supporting Structure

The supporting hangers and their fixings should be capable of bearing the load of the complete cable system including any applied insulation material or other services suspended from it. Chemical anchors are not generally suitable. It is usually not advisable to use unprotected hangers if the stress exceeds 6N/mm² and/or if hanger lengths exceed 2000mm. The hanger centres should not exceed the distance limits given for the relevant system.

4. Penetrations through Walls and Floors

Care should be taken to ensure that movement of the cable duct system in ambient or in fire conditions does not adversely affect the performance of the wall, partition or floor or any penetration seal.

5. Other Requirements

Acoustic performance, thermal insulation, water tolerance, strength and appearance can also be important.

Selection of Board Type and Thickness

The Promat systems based on Promat PROMATECT®-L500 or Promat DURASTEEL® would generally be preferred in very onerous conditions.

The board thickness will depend on the required fire performance, the internal dimensions of the duct, and whether or not the duct lid is fixed, as shown in the tables on the following page.

Cable Protection

EXTERNAL FIRE

The board thicknesses given in Tables 6q and 6r will ensure that when the duct is exposed to a fully developed cellulosic external fire (BS 476: Part 20: 1987 curve), the cable jacket temperature rise will not exceed 120°C and the cables will remain functioning. If the cables are not required to maintain circuit integrity it may be possible to reduce the board thickness after consultation with the Promat Technical Services Department. Promat can also advise on specifications for larger duct sizes.

FIBRE OPTICS

These cables have a lower failure temperature and therefore the Promat Technical Services Department should be consulted to determine the required board thickness and construction details.

INTERNAL FIRE

The board thicknesses given in Tables 6s and 6t will ensure that the stability, integrity and insulation of the duct will be maintained when exposed to a fully developed cellulosic internal fire (BS 476: Part 20: 1987 curve).

For ducts which do not require to satisfy the insulation criteria, and for larger ducts, please consult the Promat Technical Services Department.

Table 6q Internal Cross Section $\leq 110 \times 100\text{mm}$

Lid Type	Thickness of board for different fire resistance (minutes)				Board type
	30	60	90	120	
Loose Fit	25mm	45mm	60mm	80mm	Promat PROMATECT®-L500
Fixed	20mm	40mm	60mm	80mm	Promat PROMATECT®-L500

Table 6r Internal Cross Section $\geq 110 \times 100\text{mm} \leq 520 \times 250\text{mm}$

Lid Type	Thickness of board for different fire resistance (minutes)				Board type
	30	60	90	120	
Loose Fit	20mm	40mm	60mm	70mm	Promat PROMATECT®-L500
Fixed	20mm	35mm	50mm	70mm	Promat PROMATECT®-L500

Table 6s: For Stability, Integrity in Fire Compartment/Insulation in Adjacent Compartment

Thickness of board for different fire resistance (minutes)				Board type
30	60	90	120	
20mm	30mm	35mm	40mm	Promat PROMATECT®-L500

Table 6t: For Stability, Integrity and Insulation in Fire Compartment

Thickness of board for different fire resistance (minutes)				Board type
30	60	90	120	
25mm	35mm	40mm	52mm	Promat PROMATECT®-L500

Assessment No CC 211899 PUKL

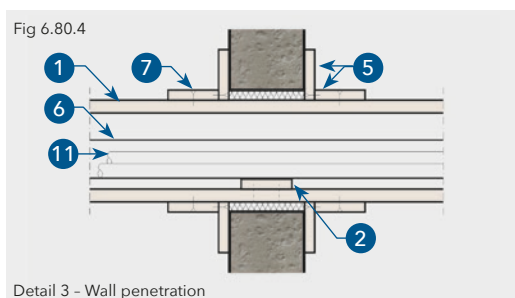
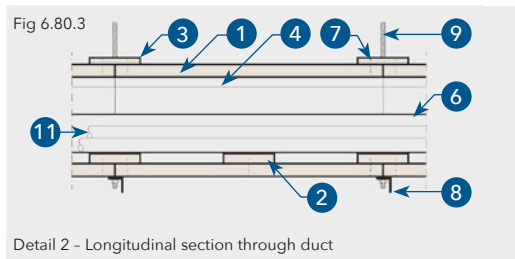
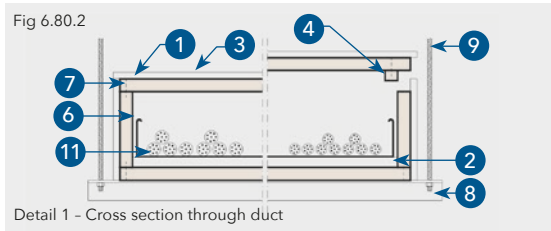
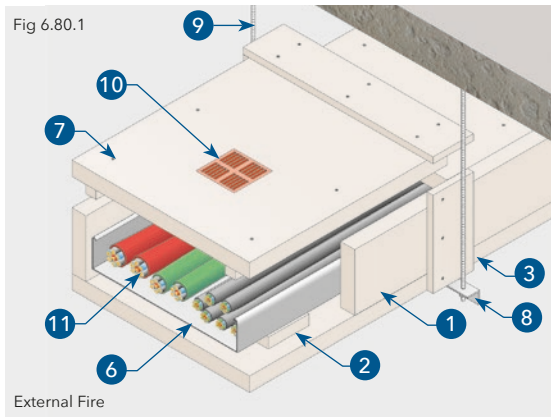

EXTERNAL FIRE

TECHNICAL DATA

Up to 120 minutes fire rating, integrity and insulation in accordance with the criteria of BS 476: Part 20: 1987.

1. Promat PROMATECT®-L500 in accordance with Tables 6q or 6r on page 6.13.
2. Promat PROMATECT®-L500 or Promat SUPALUX® internal strip, 100mm x 20mm thick, located between tray and base of duct only. Strips positioned at maximum 625mm centres and coinciding with board joints and supports.
3. Promat PROMATECT®-L500 external cover strip to top and side joints only, 100mm x 20mm thick (up to 60 minutes) or 100mm x 25mm, (over 60 minutes). These strips are not required for multi-layer constructions providing the joints between the layers are staggered by at least 80mm and fixed to each other.
4. Promat PROMATECT®-L500 batten, 25mm x 20mm thick, fixed to loose fit lid (not required for fixed lid option).
5. At wall penetrations, seal gaps up to 20mm wide with mineral wool and Promat PROMASEAL® Sealant. For gaps greater than 20mm fix a Promat PROMATECT®-L500 collar on both sides of the wall, minimum collar dimensions 150mm x 20mm thick.
6. Steel cable tray.
7. Fixing options as below (Table 6U). Screws should be deep-threaded, self-tapping, drywall type e.g. Buildex HILO. Alternatively, steel staples can be used.
8. Support angle or channel, size will depend on load. Maximum permissible bending stress 6N/mm². Supports should be at maximum 1250mm centres and should coincide with an internal cover strip (2). The cable duct should be supported not more than 500mm from either side of the wall.
9. Threaded steel hanger rod, minimum diameter 8mm at maximum 1250mm centres, ensure maximum stress does not exceed 6N/mm².
10. Promat PROMASEAL® Ventilation Grille to prevent excessive heat build up in duct during non-fire conditions.
11. Electrical cables

Note: Fibre optic cables have a lower failure temperature and therefore the Promat Technical Services Department should be consulted to determine the required board thickness.

Table 6u

Board thickness (mm)	Screws at 200mm centres	Staples at 100mm centres
20	38mm x No.6	50/11/1.5
25	50mm x No.6	63/11/1.5
30	63mm x No.8	63/11/1.5
35	63mm x No.8	70/12/2
40	75mm x No.8	80/12/2
50	100mm x No.10	80/12/2
60	100mm x No.10	90/12/2
70	Multi-layer	Fix layer 1 with screws
80	Multi-layer	Fix layer 1 with screws

Cable Protection

INTERNAL FIRE

TECHNICAL DATA

Up to 120 minutes fire rating, integrity and insulation in accordance with the criteria of BS 476: Part 20: 1987.

1. Promat PROMATECT®-L500 in accordance with Tables 6s or 6t on page 6.13.
2. Promat PROMATECT®-L500 or Promat SUPALUX® internal strip, 100mm x 20mm thick, located between tray and base of duct only. Strips positioned at maximum 625mm centres and coinciding with board joints and supports (8).
3. Promat SUPALUX® external cover strips, 100mm x 9mm thick, to top and side joints only. For ducts with an internal height greater than 300mm replace the external strip with an internal Promat SUPALUX® strip, 100mm x 15mm thick. Fix side boards to ends of internal strip to strengthen casing, external strips not required for multi-layer construction providing the joints between layers are staggered by at least 80mm and fixed to each other.
4. Promat PROMATECT®-L500 or Promat SUPALUX® batten, 25mm x 20mm thick, fixed to loose fit lid (not required for fixed lid option).
5. At wall penetrations, seal gaps up to 20mm wide with mineral wool and Promat PROMASEAL® Sealant. For gaps greater than 20mm fix a Promat PROMATECT®-L500 or Promat SUPALUX® collar on both sides of the wall, minimum collar dimensions 150mm x 20mm thick.
6. Steel cable tray (not required for internal fire exposure unless the cable weight exceeds 25kg/m, then a cable tray should be used or the hanger centres should be reduced).
7. Fixing options as below. Screws should be deep-threaded, self-tapping, drywall type e.g. Buildex HILO. Alternatively, steel staples can be used.
8. Support angle or channel size will depend on the maximum permissible bending stress 6N/mm². Supports should be at maximum 1250mm centres and should coincide with an internal cover strip (2). The cable duct should be supported not more than 500mm from either side of the wall.
9. Threaded steel hanger rod, minimum diameter 8mm at maximum 1250mm centres, ensure maximum stress does not exceed 6N/mm².
10. Promat PROMASEAL® Ventilation Grille to prevent excessive heat build up in duct during non-fire conditions.
11. Electrical cables.

Table 6v

Board thickness (mm)	Screws at 200mm centres	Staples at 100mm centres
9	25mm x No.6	28/10/1.2
15	30mm x No.6	32/10/1.2
20	38mm x No.6	50/11/1.5
25	50mm x No.6	63/11/1.5
30	63mm x No.8	63/11/1.5
35	63mm x No.8	70/12/2
40	75mm x No.8	80/12/2
50	100mm x No.10	80/12/2
60	100mm x No.10	90/12/2
70	Multi-layer	Fix layer 1 with screws

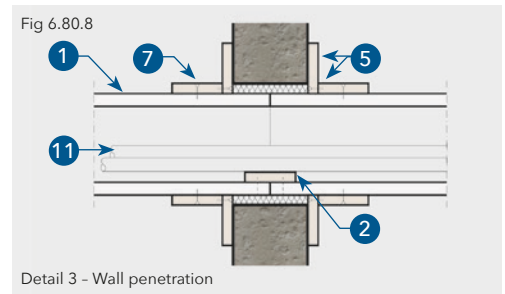
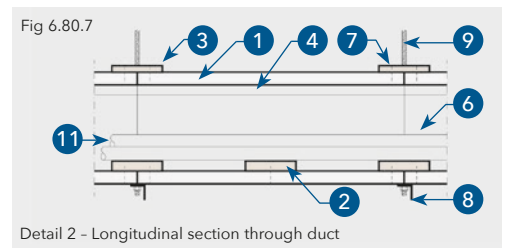
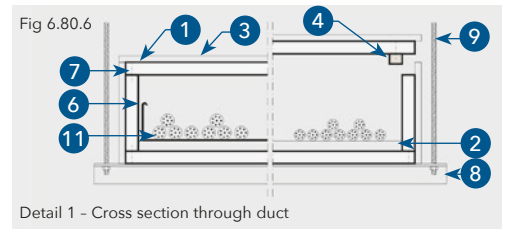
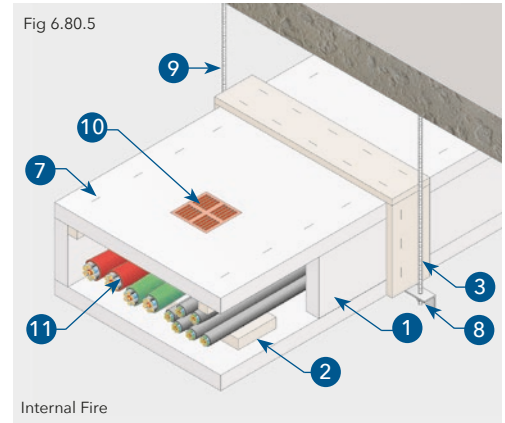

Cable Protection - External or Internal Fires

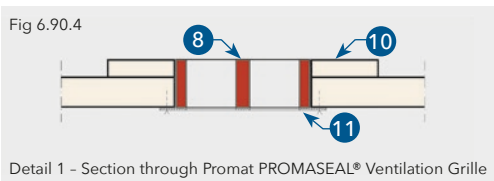
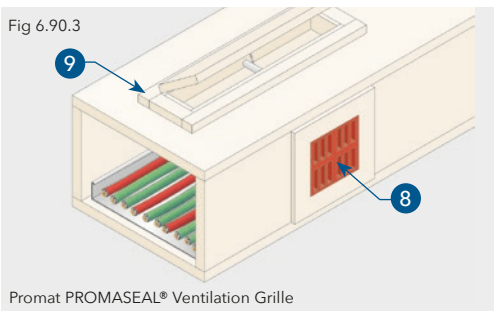
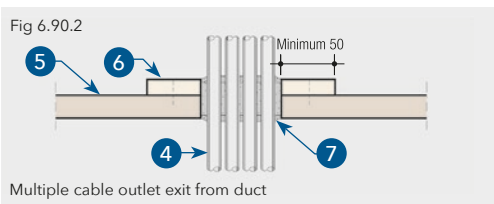
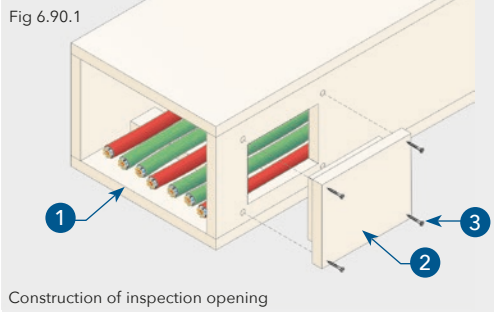

ACCESS HATCHES AND VENTILATION OPENINGS

For the installation and inspection of cables, a loose lid construction may be employed as described on pages 6.13 or 6.15. Alternatively, the lid can be fixed and inspection openings with hatches can be provided in the side walls of the duct as shown.

TECHNICAL DATA

Up to 120 minutes fire rating, integrity and insulation in accordance with the criteria of BS 476: Part 20: 1987.

1. Promat PROMATECT®-L500 system encasing cable run.
2. Promat PROMATECT®-L500 inspection hatch comprising:
 - a) Inner board stapled or secured to outer board. The inner board should be a close fit in the opening and should be the same thickness as the wall of the duct.
 - b) Outer board, at least 20mm thick, overlapping duct walls by at least 50mm.
3. Secure complete hatch to duct using threaded inserts e.g. Tecserts (Armstrong Fastening Systems) at maximum 200mm centres.
4. Electric cables.
5. Wall of Promat PROMATECT®-L500 system.
6. Promat PROMATECT®-L500, at least 50mm wide x 20mm thick, secured to main panel using fixings given in the tables on pages 6.14 or 6.16
7. Seal gaps for full depth of board thickness with Promat PROMASEAL® Sealant. Ventilation for the cables can be provided by either Promat PROMASEAL® Ventilation Grille (8).

Detail 1 - Section through Promat PROMASEAL® Ventilation Grille

- Standard Grille size is 93mm x 93mm overall. Can be combined as multiples to create a larger free area
- Open area per Grille = 0.0035m².
- Grille dimensions 93mm x 93mm x 35mm
- Friction fit Grille (8) in aperture. Use Promat PROMACOL®-S adhesive if loose fit.
- Secure 50mm wide cover strips (10) if necessary to ensure Grille fully surrounded by board.
- The Grille is supported on the inside of the duct by a perforated steel plate (supplied) (11) secured to the duct wall.

Service Enclosures

SERVICE ENCLOSURES

For the provision of fire resisting constructions to general building services,

60 to 240 minutes fire rating (integrity with varying periods of insulation), in accordance with the performance criteria of BS 476: Part 20: 1987.

No specific British Standard exists to cover fire protection to building services, therefore for the provision of fire resisting constructions to cable ducts and general building services, Promat constructions have been tested in accordance with the criteria of German DIN 4102, or British Standard BS 476: Part 20: 1987 and assessed to the criteria of BS 476: Part 24: 1987.

These assessments include allowance for both internal and external fire. The integrity and, where pertinent, the insulation performance of the enclosure, and any penetrations through compartment walls and floors, are measured.

Circuit integrity of electrical cables, or ability of the services to function, are not measured and do not constitute part of the failure criteria. Where circuit integrity of electrical cables is required, please refer to the cable protection section of this chapter.

For the provision of a protection system which will ensure the ability of other services to function unimpaired in case of fire (e.g. fuel pipes, water mains), please contact the Promat Technical Services department.

VERTICAL AND HORIZONTAL SERVICE ENCLOSURES - FIXING TO ANGLES

TECHNICAL DATA (1, 2, 3 and 4 sided enclosures)

Promat PROMATECT®-L500 enclosures

Up to 240 minutes fire rating, integrity with various periods of insulation, in accordance with criteria of BS 476: Part 20: 1987 Internal or external fire.

1. Promat PROMATECT®-L500 boards, thickness in accordance with table 6w below.
2. Metal angle framing, consult Promat Technical Services Department. Minimum 30mm x 30mm x 0.8mm angles up to 50mm x 50mm x 1.2mm. Steel channel may be required. Additional framing may be required according to span and impact requirements of construction.
3. M4 screws at 250mm centres, screw length to provide minimum 10mm penetration through angle. Two or three sided casings: fix steel angles to suitable fire resisting wall or soffit using M4 screws into non combustibile plugs: screw length to provide minimum 30mm penetration into plugs.
4. Butt joints must have 75mm wide backing strip inside circumferential joints, if joint not backed by angle. Thickness of backing strip to be same as that required for board encasement.

Please contact Promat Technical Services for details of fixing for Promat service enclosures.

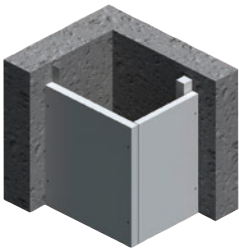
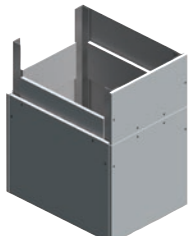
Angle fix method	Product		Fire Rating Stability/ Integrity/Insulation	Maximum Size
	Promat PROMATECT®-L500	20mm thick	120/120/15	1200mm x 1200mm
		25mm thick	120/120/30	1200mm x 1200mm
		35mm thick	120/120/60	1200mm x 1200mm
		40mm thick	120/120/90	1200mm x 1200mm
		50mm thick	240/240/120	1200mm x 1200mm Assessment No. WF 169597
	Promat DURASTEEL®	9.5mm thick	240/240/-	1500mm x 1500mm Assessment No. WF 169601

Horizontal Service Enclosures, Suspended Services

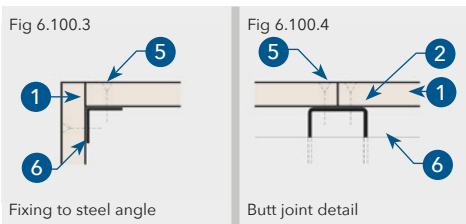
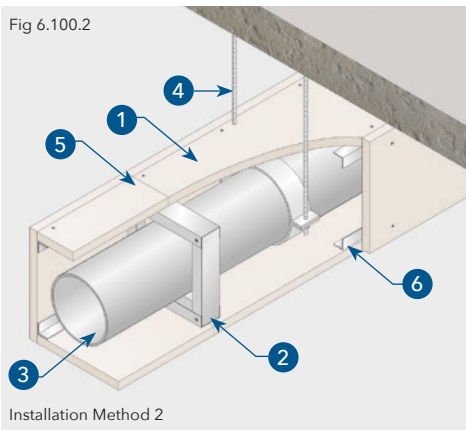
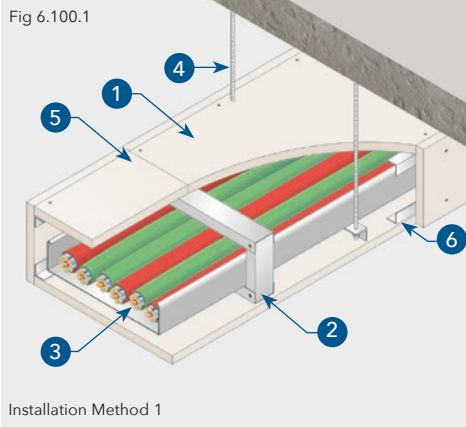

PROMAT PROMATECT®-L500 ENCLOSURES

TECHNICAL DATA

Up to 240 minutes fire rating, integrity in accordance with the criteria of BS 476: Part 20: 1987; internal or external fire.

1. Fire protection boards, thickness in accordance with table 6x below.
2. Steel channel collar, minimum 50mm x 25mm x 0.8mm thick, at board joints or maximum 1220mm centres.
3. General M & E services e.g. cable trunking, steel pipes, etc.
4. Hanger diameter sized to limit stress not to exceed 10N/mm² (for 120 minutes) or 6N/mm² (for 240 minutes).
5. M4 self-tapping screws at nominal 200mm centres.
6. Steel angle, minimum 30mm x 30mm x 0.8mm thick, at corners.

Note: Solutions for the construction of systems with 1, 2 and 3-side used in combination with walls and ceilings are approved. Details on request.

For enclosures with a width exceeding 1220mm, the steel channel collar (2) shall be spaced at centres such to ensure a maximum unsupported area not exceeding 1.5m². The maximum approved width of the construction detail is 3000mm.

If the M & E service (3) being encased is a plastic pipe, external hangers and angles with stress 10N/mm² will be required to independently support the enclosure.

Table 6x Horizontal Service Enclosures

Integrity and Insulation	Product	Fire Rating Stability/ Integrity/ Insulation	Maximum Size
	Promat PROMATECT®-L500	20mm thick	120/120/15 1200mm x 1200mm
		25mm thick	120/120/30 1200mm x 1200mm
		35mm thick	120/120/60 1200mm x 1200mm
		40mm thick	120/120/90 1200mm x 1200mm
		50mm thick	240/240/120 1200mm x 1200mm Assessment No. WF 169597
	Promat DURASTEEL®	9.5mm thick	240/240/- 1500mm x 1500mm Assessment No. WF 169601

DURASTEEL Horizontal Service Enclosure, Suspended Services

PROMAT DURASTEEL®

Promat DURASTEEL® enclosures provide protection against fire to cable ducts and general building services in accordance with the relevant criteria of BS 476: Parts 20: 1987 and 22: 1987.

Promat DURASTEEL® systems are suitable for providing protection to services even under extremely aggressive environments.

The Promat DURASTEEL® systems described below ensure the integrity of fire compartments. If the services are required to continue functioning in the event of fire, please consult the Promat Technical Services Department.

The maximum permissible dimensions for enclosures are up to 6000mm x 1500mm for up to 240 minutes fire resistance. For hanger sizes please consult Promat Technical Services Department.

TECHNICAL DATA

1. Promat DURASTEEL® boards, thickness in accordance with table 6x on page 6.18.
2. Steel flanges, fabricated by cutting and welding 50mm x 50mm x 3mm thick angles, are bolted together with M8 nuts and bolts at nominal 250mm centres to form continuous sections.
3. Cable tray or services enclosure.
4. Corner steel angle reinforcement, 50mm x 50mm x 3mm thick, these corner angles do not require any mechanical fixing to the flanges (2).
5. Support channels, sized according to duct weight, size and required fire resistance.
6. Steel hanger rods, sized according to duct weight, size and required fire resistance.
7. Cables or services.

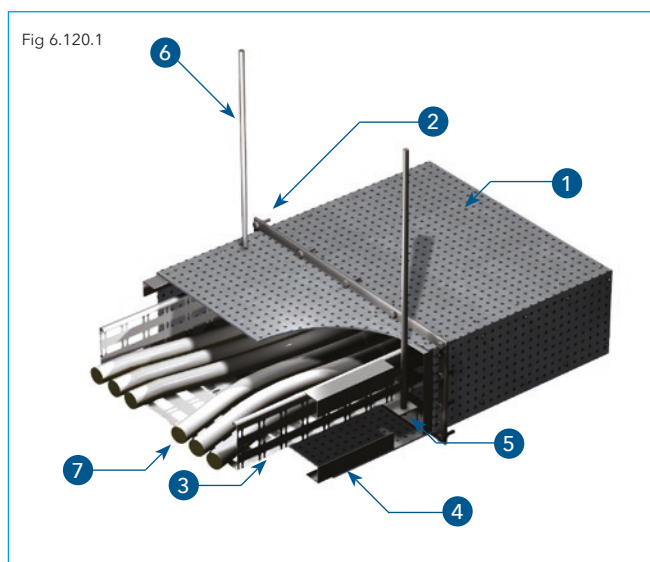

GB ORDERLINE

For placing orders, delivery enquiries
and local stockists etc.

T: 0800 373 636

F: 01275 379 037

E: orderline@promat.co.uk

TECHNICAL SERVICES

For technical support and advice.

T: 0800 145 6033 or 01275 377 789

E: technical@promat.co.uk

RESOLUTIONS

For any problems with invoices or deliveries.

T: 01275 379 031 or 0800 373 636

E: customer.support@promat.co.uk

Etex Building Performance Limited

Marsh Lane, Easton-in-Gordano,

Bristol, BS20 0NE

T: 0800 373 636 F: 01275 379 037

promat.com

© 2023 Etex Building Performance Limited

V1(c) 17/02/2023